

SHARP®

MODEL

AR-207

DIGITAL LASER COPIER

OPERATION MANUAL

	Page
• GETTING STARTED	2
• MAKING COPIES	13
• SPECIAL FEATURES	32
• STATUS INDICATORS	42
• GENERAL INFORMATION	51
• OPTIONAL EQUIPMENT	69

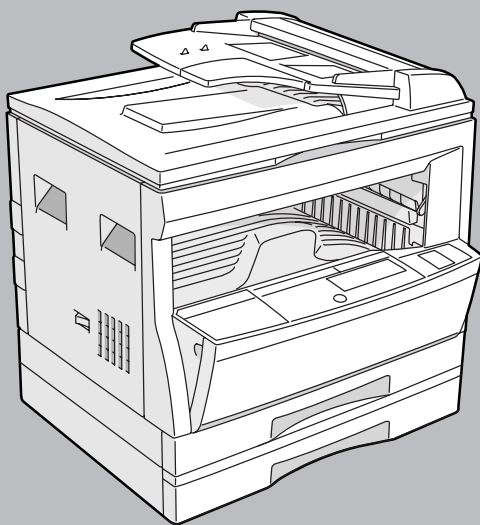

FOR YOUR RECORDS ...

To protect against loss or theft, record and retain for reference the copier's serial number located on the back of the unit.

Model Number AR-207
Serial Number _____
Date of Purchase _____
Place of Purchase _____
Authorized Sharp Copier
Service Department Number _____

CAUTIONS

Follow the cautions below when using this copier.



- The fusing area is hot. Exercise care in this area when removing misfed paper.
- Do not look directly at the light source. Doing so may damage your eyes.



- The socket-outlet shall be installed near the equipment and shall be easily accessible.
- Place the copier on a firm, level surface.
- Do not install the copier in a humid or dusty location.
- When the copier is not used for a long time, for example, during prolonged holidays, turn the power switch off and remove the power cord from the outlet.
- When moving the copier, be sure to turn the power switch off and remove the power cord from the outlet.
- Do not cover the copier with a dust cover, cloth or plastic film while the power is on. Doing so may prevent heat dissipation, damaging the copier.
- Use of controls or adjustments or performance of procedures other than those specified herein may result in hazardous laser radiation exposure.

SAFETY PRECAUTIONS

This Digital Copier is rated Class 1 and complies with 21 CFR 1040.10 and 1040.11 of the CDRH standards. This means that the copier does not produce hazardous laser radiation. For your safety, observe the precautions below.

- Do not remove the cabinet, operation panel or any other covers.
- The copier's exterior covers contain several safety interlock switches. Do not bypass any safety interlock by inserting wedges or other items into switch slots.

CONTENTS

Page

GETTING STARTED

● INTRODUCTION	2
● MAIN FEATURES	3
● PART NAMES AND FUNCTIONS	4
– Overall layout	4
– Operation panel	6
● COPIER INSTALLATION	8
● CAUTIONS ON HANDLING	9
●  LOADING COPY PAPER	10

GETTING STARTED

MAKING COPIES

● AUDITING ACCOUNTS	13
● NORMAL COPYING	14
● COPYING FROM THE ORIGINAL TABLE	19
● REDUCTION/ENLARGEMENT/ZOOM	23
● BYPASS FEED (special paper)	25
● SORT/GROUP	27
● INTERRUPTING A COPY RUN	29
● AUTOMATIC EXPOSURE ADJUSTMENT	30
● TONER SAVE MODE	31





MAKING COPIES

SPECIAL FEATURES

● XY ZOOM	32
● B/W REVERSE	34
● DUAL PAGE COPY	35
● ROTATION COPYING	36
● 2 IN 1 OR 4 IN 1	37
● ERASE	39
● MARGIN SHIFT	41

SPECIAL FEATURES

STATUS INDICATORS

●  TONER CARTRIDGE REPLACEMENT	42
●  MISFEED REMOVAL	44
●  DEVELOPER REQUIRED	50
●  MAINTENANCE REQUIRED	50

STATUS INDICATORS

GENERAL INFORMATION

● USER PROGRAMS	51
– Settings for auditing accounts	54
● POWER SAVE MODES	58
● USER MAINTENANCE	60
● COPIER TROUBLE?	62
● SUPPLIES	65
– Types and sizes of copy paper	65
– Genuine supplies statement	66
● SPECIFICATIONS	67

GENERAL INFORMATION

OPTIONAL EQUIPMENT

● SYSTEM CONFIGURATION	70
● 250-SHEET PAPER FEED UNIT (AR-DE5)/ 2x250-SHEET PAPER FEED UNIT (AR-DE6)	71

OPTIONAL EQUIPMENT

INDEX	74
-------	----

INTRODUCTION

This copier has been designed to provide convenient copying features in a minimum amount of office space and with maximum operational ease. To get full use of all copier features, be sure to familiarize yourself with this manual and the copier.

For quick reference during copier use, keep this manual in a handy location.



Note

- This copier can be used as a laser printer and as a facsimile machine by installing optional components. However, this manual describes only the copier features. For description of the printer features and facsimile features, see their separate manuals.
- Depending on the country or area, some keys of this copier will be indicated with either an English name or a symbol. —Example: XY-ZOOM (H) key, START (Ⓢ) key.

Conventions used in this manual

In this manual, the following icons are used to provide the user with information pertinent to the use of the copier.



Warning

Warns the user that injury to the user or damage to the copier may result if the contents of the warning are not properly followed.



Caution

Cautions the user that damage to the copier or one of its components may result if the contents of the caution are not properly followed.



Note

Notes provide information relevant to the copier regarding specifications, functions, performance, operation and such, that may be useful to the user.



Indicates a letter displayed in the copy quantity display.

MAIN FEATURES

① High-speed laser copying

- First-copy time is only 7.2 seconds (except in a power save mode or immediately after power on).
- Copying speed is 20 copies/min., which adapts to business use, allowing improvement of working efficiency.

② High-quality digital image

- High-quality copying at 600 dpi is performed.
- In addition to the automatic exposure mode, the manual exposure can be adjusted in five steps.
- The photo mode copying function allows clear copying of delicate halftone original images such as monochrome photos and color photos. Photo mode is adjustable in five steps.

③ Substantial copying features such as:

- Copies up to ledger size originals from the original table, or through the 30 sheet automatic document feeder
- Continuous copying up to 99 sheets
- Scan once/print many to increase reliability and productivity
- 8 pre-set reduction and enlargement ratios plus 50% - 200% zoom in 1% increments
- Automatic two-sided copying can be performed.
- Electronic sorting eliminates the need for a bulky, mechanical sorter
- Dual page copy mode for books, magazines and manuals
- Editing features like XY zoom and black/white reverse
- Digital editing features like 2 IN 1/4 IN 1 copying

④ Optional features

- This copier can be used as a laser printer by installing an optional printer expansion kit.
- This copier can be used as a facsimile machine by installing an optional facsimile expansion kit.

⑤ Environmentally friendly design

- Paper output tray is housed in the copier for space saving.
- Preheat and auto power shut-off modes are provided to reduce power consumption in standby mode and meet the Energy Star Guidelines.



As an ENERGY STAR® Partner, SHARP has determined that this product meets the ENERGY STAR® guidelines for energy efficiency.



The Environmental Choice Program guidelines are applied to the products only in Canada. The products that meet the Environmental Choice Program guidelines carry the logo shown to the left. The products without the logo may not meet the Environmental Choice Program guidelines.

PART NAMES AND FUNCTIONS

Overall layout

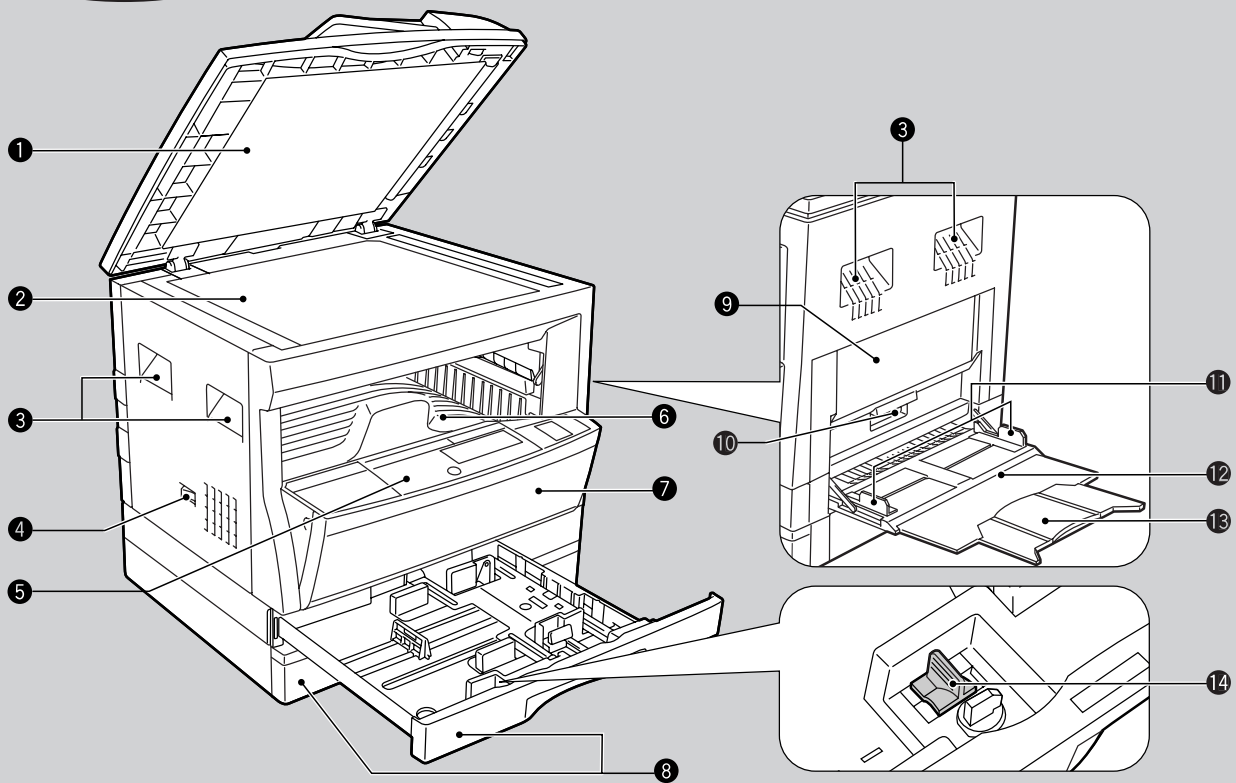

1 Document feeder cover

Open to make copies from the original table.

2 Original table

All originals which cannot be copied from the RSPF must be copied here.

3 Handles

Use to move the copier.

4 Power switch

Press to turn the copier power on and off.

5 Operation panel

All copier controls are located here for easy operation.

6 Paper output tray

Finished copies are deposited in the paper output tray.

7 Front cover

Open to remove misfeeds and for copier servicing.

8 Paper trays

Each tray holds 250 sheets of copy paper.

9 Side cover

Open to remove misfeeds and to service the copier.

10 Side cover handle

Lift and pull to open the side cover.

11 Bypass tray guides

Adjust to the width of the copy paper.

12 Bypass tray

Paper including special paper (such as transparency film) can be fed from the bypass tray.

13 Bypass tray extension

Pull out when feeding large paper such as 8-1/2" x 14" and 11" x 17".

14 Charger cleaner

Use to clean the transfer charger.

15 Document feeder tray

Holds up to 30 originals.

16 Original guides

Adjust to the size of the originals.

Reversing single pass feeder (RSPF)

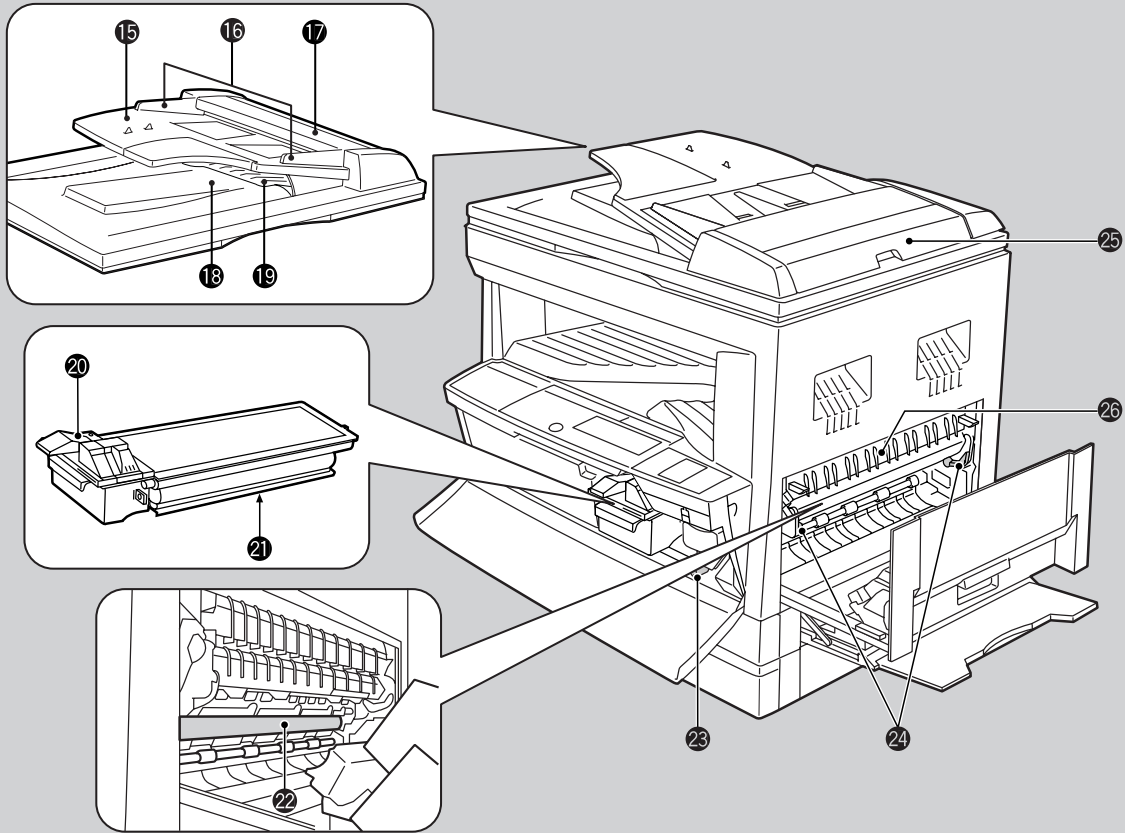

- 17 Feeding roller cover**
Open to remove misfed originals.
- 18 Exit area**
Finished originals are output here.
- 19 Reversing tray**
Pull out to remove misfed originals.
- 20 Toner cartridge lock release lever**
Use to unlock the toner cartridge.
- 21 Toner cartridge**
Contains toner.
- 22 Photoconductive drum**
Copy images are formed on the photoconductive drum.
- 23 Roller rotating knob**
Turn to remove misfed paper.
- 24 Fusing unit release levers**
Lower to remove misfed paper.

 **Warning** The fusing unit is hot.
Take care in removing paper.

- 25 Right side cover**
Open to remove misfed originals.
- 26 Paper guide**
Open to remove misfed paper.

Accessories	
Operation manual	1
Charger cleaner	1

PART NAMES AND FUNCTIONS

GETTING STARTED

Part names and functions

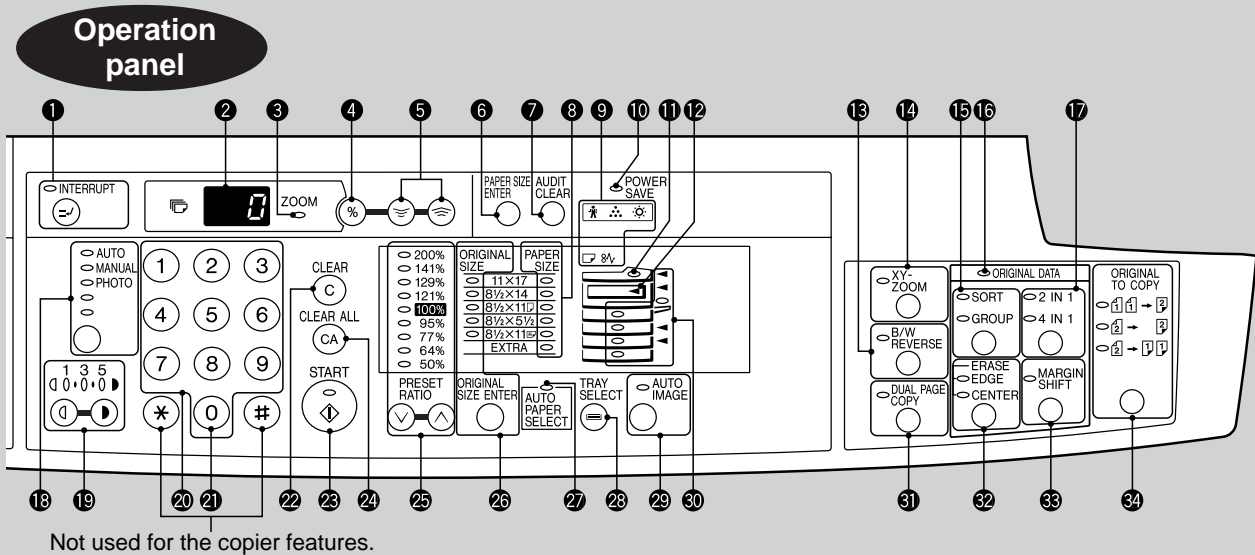

- 1 INTERRUPT key and indicator** (p. 29)
Interrupts a copy run.
- 2 Copy quantity display**
Displays the specified copy quantity during the ready condition and displays the copy countdown as copies are made. Also see items **4** and **21**.
- 3 ZOOM indicator** (p.24)
Lights up when a zoom ratio is set.
- 4 Copy ratio display key** (p. 24)
Press and hold down during standby to display the copy ratio in the copy quantity display.
- 5 Zoom keys** (p. 24)
Use to select any reduction or enlargement copy ratio from 50% to 200% in 1% increments.
- 6 PAPER SIZE ENTER key** (p.12)
Use to set the paper size in paper trays.
- 7 AUDIT CLEAR key** (p.13)
Closes an open account.
- 8 PAPER SIZE indicators**
Light up to show the selected copy paper size.
- 9 Alarm indicators**
 - : Maintenance indicator (p. 50)
 - : Toner cartridge replacement required indicator (p. 42)
 - : Developer replacement required indicator (p. 50)
 - : Paper required indicator (p. 10)
 - : Misfeed indicator (p. 44)
- 10 POWER SAVE indicator** (p. 58)
Lights up when the copier is in a power save mode.
- 11 RSPF indicator** (p. 14)
Lights up when originals are set in the document feeder tray.
- 12 Output tray full indicator**
Indicates documents must be removed from the paper output tray.
- 13 B/W REVERSE key and indicator** (p. 34)
Press to reverse the black and white areas.
- 14 XY-ZOOM key and indicator** (p. 32)
Press to change the horizontal and vertical copy ratios independently.
- 15 SORT/GROUP key and indicators** (p. 27)
Press to select the sort or group mode.
- 16 ORIGINAL DATA indicator**
Blinks when the memory becomes full of scanned original image data.
- 17 2 IN 1 / 4 IN 1 key and indicators** (p. 37)
Press to select the 2 in 1 or 4 in 1 mode.
- 18 AUTO/MANUAL/PHOTO key and indicators** (p. 15)
Use to sequentially select the exposure modes: AUTO, MANUAL, or PHOTO.
- 19 Light and dark keys and indicators** (p. 15)
Use to adjust the MANUAL or PHOTO exposure level.
- 20 Numeric keys**
Use to select the desired copy quantity or to make user program entries.
- 21 Zero key**
Use as part of numeric keys to enter copy quantity. Press during a continuous copy run to display the number of copies completed in the current run. Press and hold during standby to display the total output count.

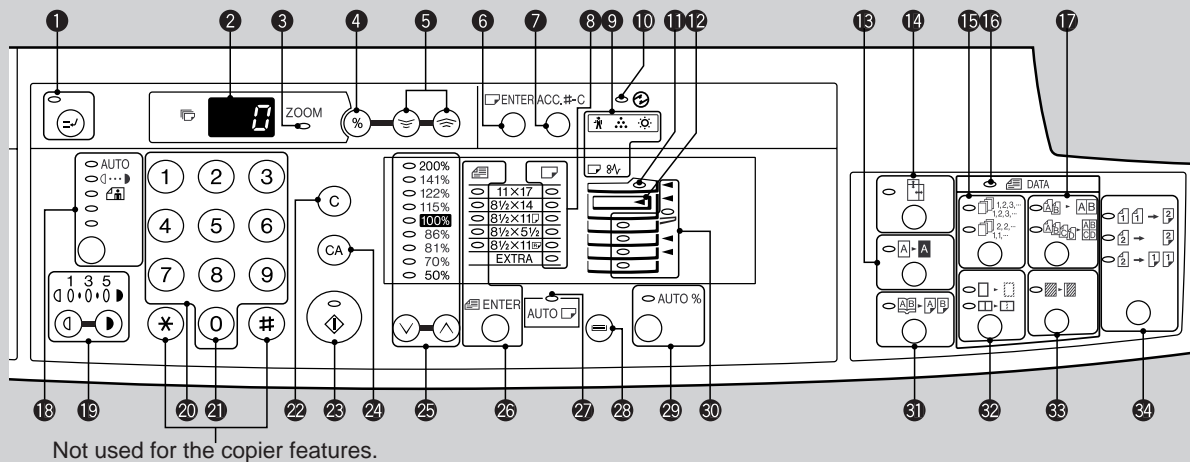

Depending on the country or area, some keys will be indicated with either an English name or a symbol.

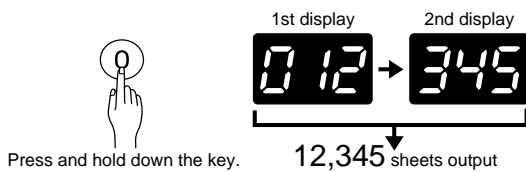

Note:

- Two-sided copies are counted as two copies.
- 11" x 17" size copies are counted as two copies.

- 22 CLEAR key**
Clears the copy quantity display or terminates a copy run.
- 23 START key and indicator**
Copying is possible when the indicator is on. Press to start copying.
- 24 CLEAR ALL (CA) key**
Clears all selected settings and returns the copier to the initial settings.
- 25 PRESET RATIO selector keys and indicators (p. 24)**
Use to sequentially select preset reduction/enlargement copy ratios: 50%, 64%, 77%, 95%, 100%, 121%, 129%, 141%, 200%.
- 26 ORIGINAL SIZE ENTER key and indicators**
Use to input the original size.
- 27 AUTO PAPER SELECT indicator**
Paper of the proper size will be automatically selected depending on the original size and selected copy ratio when this indicator is on.
- 28 TRAY SELECT key (p. 15)**
Use to manually select a paper tray.
- 29 AUTO IMAGE key and indicator**
Press for automatic copy ratio selection.
- 30 Paper feed location/misfeed location indicators (p. 44)**
The selected paper feed location is shown by a lit indicator (○).

The general location of misfed paper is shown by a blinking red indicator (◀).

- 31 DUAL PAGE COPY key and indicator (p. 35)**
Use to make individual copies of two originals placed side by side on the original table.
- 32 ERASE key and indicators (p. 39)**
Press to select the edge erase and/or the center erase mode.
- 33 MARGIN SHIFT key and indicator (p. 41)**
Shifts text or image on the copy to leave a binding margin on the left (or the top) side of the copy.
- 34 ORIGINAL TO COPY key and indicators (p. 15)**
Press to select one-sided and two-sided copy modes.
 - 1 1 → 2 : Two-sided copies from one-sided originals.
 - 2 → 2 : Two-sided copies from two-sided originals.
 - 2 → 1 1 : One-sided copies from two-sided originals.

Initial settings

The copier assumes the initial settings when it is first turned on, when the CLEAR ALL (CA) key is pressed, and approximately one minute* after the last copy is made in any mode.

- Copy ratio: 100%
- Exposure: Automatic
- Copy quantity: 0
- All special copier modes: Off
- Auto paper selection: On
- Paper feed station: Previously selected paper tray

* This time (auto clear time) can be changed. See page 51, USER PROGRAMS.

COPIER INSTALLATION

Improper installation may damage the copier. Please note the following during initial installation and whenever the copier is moved.



Caution

If the copier is moved from a cool place to a warm place, condensation may form inside the copier. Operation in this condition will cause poor copy quality and malfunctions. Leave the copier at room temperature for at least 2 hours before use.

Do not install your copier in areas that are:

- damp, humid, or very dusty
- exposed to direct sunlight
- poorly ventilated
- subject to extreme temperature or humidity changes, e.g., near an air conditioner or heater.

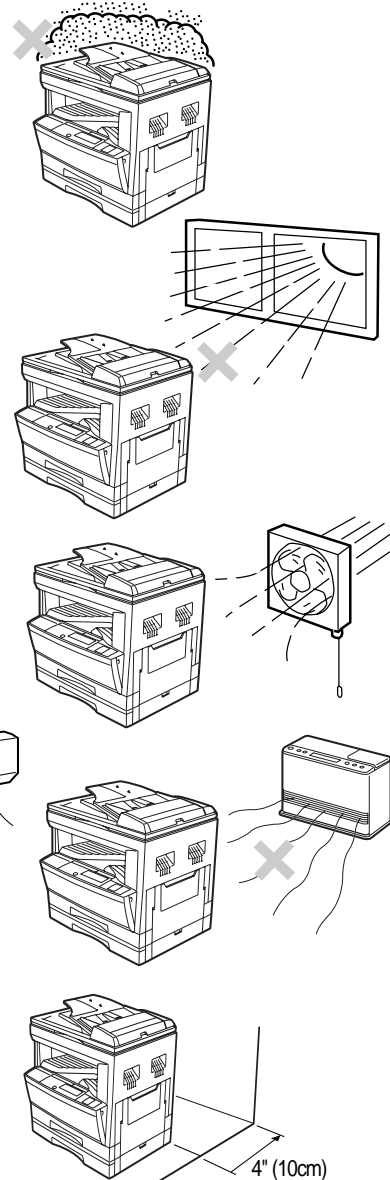

The copier should be installed near an accessible power outlet for easy connection.

Be sure to connect the power cord only to a power outlet that meets the specified voltage and current requirements. Also make certain the outlet is properly grounded.



Note

Connect the copier to a power outlet which is not used for other electric appliances. If a lighting fixture is connected to the same outlet, the light may flicker.

Be sure to allow the required space around the machine for servicing and proper ventilation.

A small amount of ozone is produced within the copier during operation. The emission level is insufficient to cause any health hazard.

NOTE:

The present recommended long term exposure limit for ozone is 0.1 ppm (0.2 mg/m³) calculated as an 8 hr. time-weighted average concentration.

However, since the small amount that is emitted may have an objectionable odor, it is advisable to place the copier in a ventilated area.

CAUTIONS ON HANDLING

Be careful in handling the copier as follows to maintain the performance of this copier.

Do not drop the copier, subject it to shock or strike it against any object.

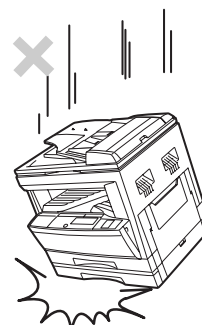

Store spare toner cartridges in a dark place without removing from the package before use.

If they are exposed to direct sunlight, poor copies may result.

Do not touch the photoconductive drum (green portion).

Scratches or smudges on the drum will cause dirty copies.



LOADING COPY PAPER

To save space, this copier has been designed with adjustable front-loading trays, which are easily opened for paper loading. For best results, use only SHARP recommended paper. (See page 65.)

The paper required () indicator will light up when there is no copy paper in the selected paper feed station, or when the selected paper tray is not installed or is improperly installed.



Note

When the paper size is changed in a paper tray, the size of the paper must be entered by steps 8 through 11 on page 12. If not, the edges of copies may become smudged with toner. Also, the AUTO PAPER SELECT and the AUTO IMAGE features will not function properly.

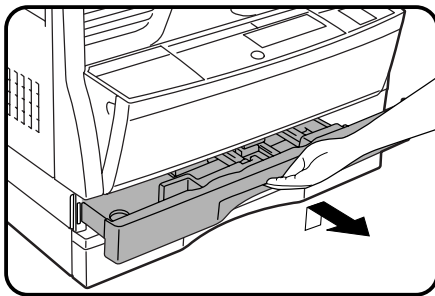

1 Gently lift and pull out the paper tray until it stops.

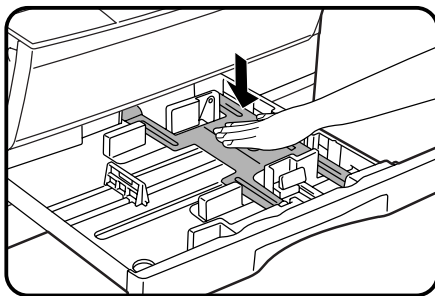

2 Push the pressure plate down until it locks in place.

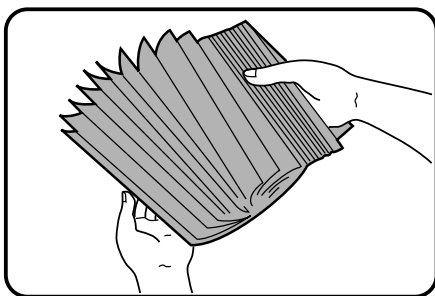

3 Fan the copy paper and insert it into the tray. Make sure the edges go under the corner hooks.

- If you change to a different size of copy paper, the tray must be adjusted. See the next page.

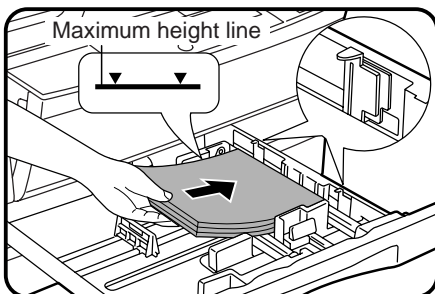

- Set the paper along the guides.
- The tray holds up to 250 sheets of 21 lb. bond paper. Do not load paper above the maximum height line.

4 Push the paper tray firmly back into the copier.

Changing the copy paper size in the tray

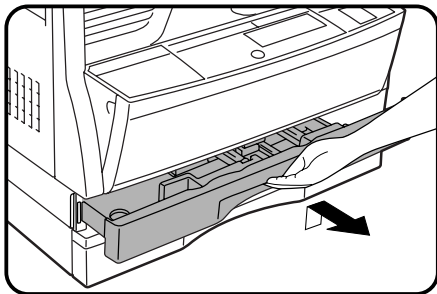

1 Gently lift and pull out the paper tray until it stops.

2 Push the pressure plate down until it locks in place.

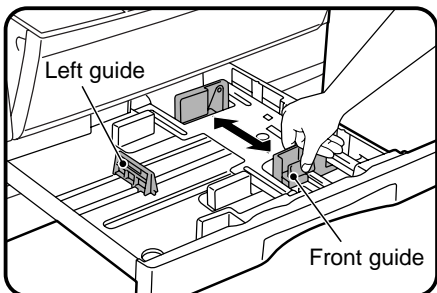

3 Squeeze the lock lever of the front guide and slide the front guide to match the width of the paper.

4 Move the left guide to the appropriate slot as marked on the tray.

- When using 5-1/2" x 8-1/2" copy paper, load it into the uppermost paper tray. If other trays (including trays in optional paper feed units) are used, paper misfeeds may occur.
- When using 11" x 17" copy paper, store the left guide in the slot at the left front of the paper tray.

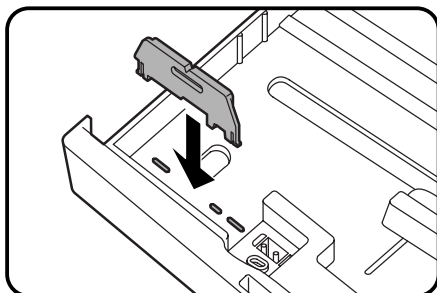

5 Load copy paper into the tray.

6 Place the appropriate label to indicate the selected paper size into the recess on the right front side of the paper tray.

7 Push the paper tray firmly back into the copier.

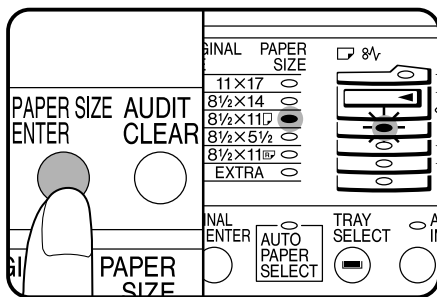

8 To set the selected paper size, press the PAPER SIZE ENTER key.

- The selected paper feed location indicator will blink and the corresponding paper size (which is currently set) indicator will light up steadily. All other indicators will go out.

Note For paper size setting, ensure that the COPY mode has been selected. However, if copying, printing or facsimile printing is being performed, paper size setting cannot be made even in the COPY mode. See Note on page 63.

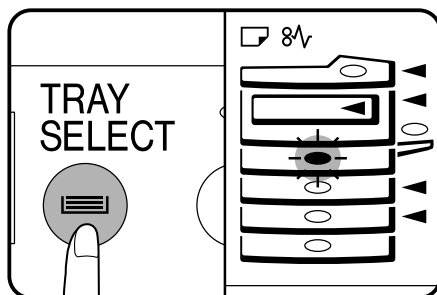

9 Use the TRAY SELECT key to select the paper tray of which the paper size has been changed.

- Each time the TRAY SELECT key is pressed, a paper tray will be indicated with a blinking paper feed location indicator.

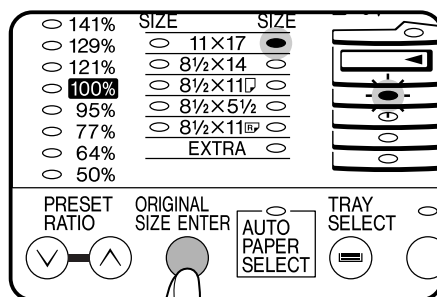

10 Use the ORIGINAL SIZE ENTER key to select the paper size which is set.

- Each time the ORIGINAL SIZE ENTER key is pressed, a paper size will be indicated with a paper size indicator.

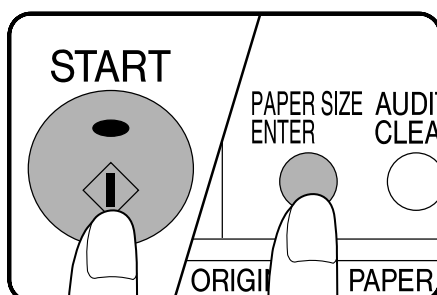

11 Press the START key and then the PAPER SIZE ENTER key.

- To change the paper size setting of another tray, repeat steps 9 to 10 after pressing the START key.

AUDITING ACCOUNTS

If this copier has been programmed in the auditing mode, it will not function until an assigned 3-digit account number has been entered. See page 54 for setting the auditing mode.

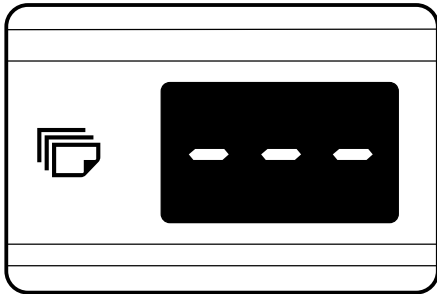

If the copier has been programmed in the auditing mode, “ — — — ” will appear in the copy quantity display in the initial conditions.

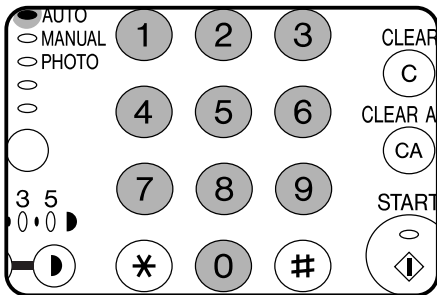

1 Enter your account number using the numeric keys.

- As each digit is entered, the dashes in the copy quantity display will disappear.
- After the number is entered, the copy quantity display will change to 0.
- If an unassigned number is entered, “ — — — ” will appear again in the copy quantity display, indicating that the number was not accepted.



2 When copying is completed, press the AUDIT CLEAR key.

- “ — — — ” will appear again in the copy quantity display, indicating the auditing mode.
- In the interrupt copy mode (see page 29), press the INTERRUPT key after an interrupt copy run is completed. All previous copier settings will be restored and the previous account number will be active.

NORMAL COPYING

This copier has two document input stations — a reversing single pass feeder (RSPF) for automatic document feeding and an original table for manual handling of bound documents. The RSPF is designed to hold up to 30 originals measuring from 5-1/2" x 8-1/2" to 11" x 17" and in the weight range of 15 to 24 lbs.

- Be sure to remove any staples or paper clips from the originals.
- Damaged or crumpled originals may misfeed in the RSPF. It is recommended that these originals be copied from the original table.
- Before placing curled or wavy originals into the document feeder tray, be sure to flatten them. If not, original misfeeds may result.
- For best feeding of originals which have binding holes punched into them, insert them so that the holes are

positioned to the right or along the side guides. In this case the settings for location of margin and image rotation in duplex copying may need to be changed to ensure the images are produced in the desired orientation. See pages 22 and 41.

- Special originals such as transparency film and tracing paper should not be fed through the RSPF but should be copied from the original table.
- The bypass tray and any tray with non-standard size paper cannot be used in the duplex copy mode.
- Paper sizes that can be used in the duplex mode are 8-1/2" x 11", 8-1/2" x 11"R, 8-1/2" x 14", and 11" x 17".
- If the offset stack mode is enabled using user program No. 19, each set of copies will be offset from the previous set in the sort and group modes.

Stream feeding mode

If the stream feeding mode has been enabled using user program No. 4, the RSPF indicator will continue to blink for approximately 5 seconds after feeding of all originals is completed. While this indicator is blinking, any new originals placed in the RSPF will be fed and copied automatically. See page 51, USER PROGRAMS.

Power on

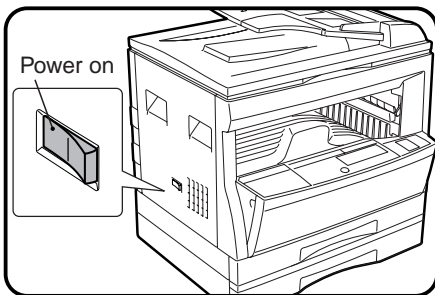

1 Turn the power switch on.

- It will take about 35 seconds for the copier to warm up. However, you can make desired settings and press the START key during warm-up. Copying will start after warm-up.
- If the copier has been programmed in the auditing mode, the START key indicator will not light up and " " will appear in the copy quantity display. Enter an assigned 3-digit account number. See page 13.
- If an optional printer expansion kit or facsimile expansion kit is installed, when the power is already on and all indicators except the POWER SAVE indicator are off, the copier is in the auto power shut-off mode. Press the START key in this case. See page 58, POWER SAVE MODES.

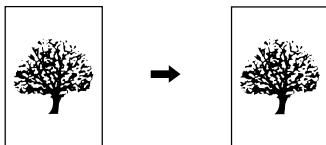

One-sided copies from one-sided originals

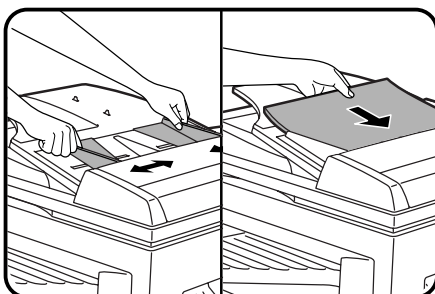

1 Ensure that no original is left on the original table.

2 Adjust the original guides to the size of the originals.

3 Set the originals face up in the document feeder tray.

- The RSPF indicator will light up. If this indicator does not light up, the originals are not properly set, or the RSPF is not properly closed.

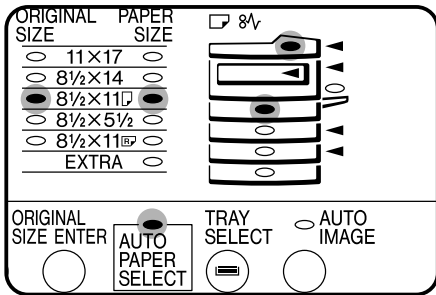

- The ORIGINAL SIZE indicator for the detected original size will light up, and the paper tray with the corresponding paper size will be automatically selected.
- The auto paper select function can be disabled using user program No. 8. If this function has been disabled, use the TRAY SELECT key to select the desired paper tray. See page 51, USER PROGRAMS.
- To copy onto a different size paper, use the TRAY SELECT key to make the selection.
- The bypass tray cannot be automatically selected.

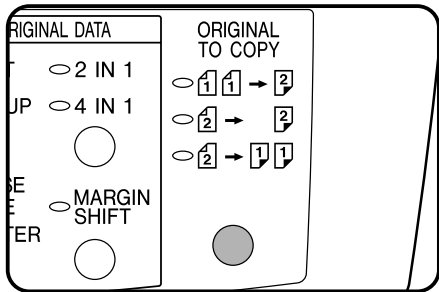

4 Ensure that the one-sided to one-sided copying mode is selected in the ORIGINAL TO COPY section of the operation panel.

- When no indicator in the ORIGINAL TO COPY section is lit, the one-sided to one-sided copying mode is selected.

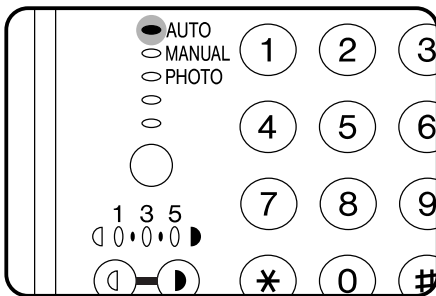

5 Adjust the copy density.

- This copier has three exposure modes to choose from—AUTOMATIC, MANUAL, and PHOTO.
- Automatic exposure is the standard initial setting for this copier. In this mode, the characteristics of the original are “read” by the exposure system and adjustments are automatically made. This optimizes the contrast of the copied images by reducing the effect of colored or shaded background areas. See page 30 to adjust the automatic exposure level.

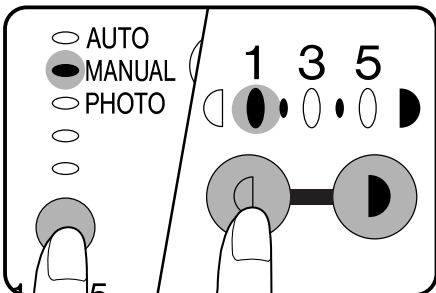

- For manual density adjustment, press the AUTO/MANUAL/PHOTO key to select MANUAL and adjust with the light (D) and dark (D) keys as desired.

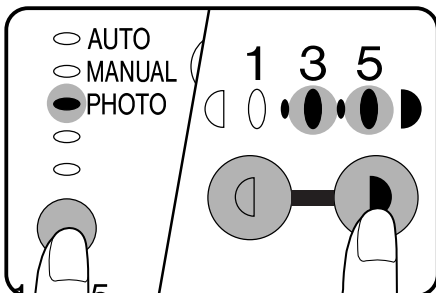

- For photographs, select PHOTO and then adjust with the light (D) and dark (D) keys as desired.
- There are 5 exposure steps indicated by 3 indicator lights. (The indicators light up one or two at a time.)
If exposure level 2 is selected, the two left-handmost indicators for that level will light up simultaneously. Also, if level 4 is selected, the two right-handmost indicators for that level will light up simultaneously.

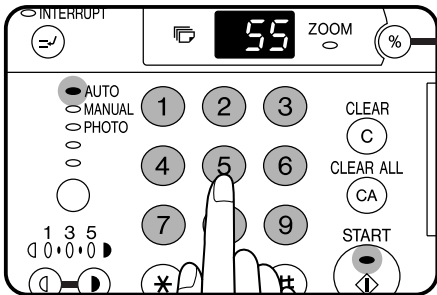

6 Set the number of copies using the numeric keys.

- A single copy can be made with the initial setting, i.e., when “0” is displayed.
- Press the CLEAR () key to clear an entry if a mistake is made.

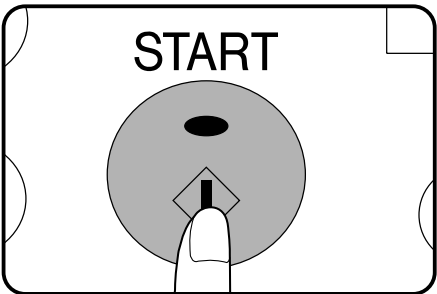

7 Press the START key.

- The number in the copy quantity display will decrease by 1 each time a copy is made.
- Press the CLEAR () key to stop copying in the middle of a run.

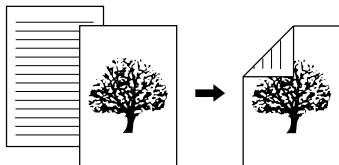

Two-sided copies from one-sided originals

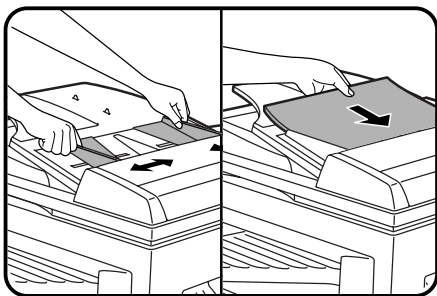

1 Ensure that no original is left on the original table. Adjust the original guides to the size of the originals and set the originals face up in the document feeder tray.

- 5-1/2" x 8-1/2" size copy paper cannot be used.
- If an uneven number of originals is set, the last copy will be one-sided.

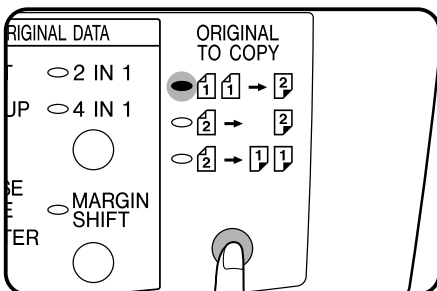

2 Use the ORIGINAL TO COPY key to select .



Note

The image of every front side can be rotated 180° using the image rotation feature. This feature is useful when the originals and copies are in the landscape (horizontal) orientation and the two-sided copies are to be read by turning them left to right rather than top to bottom. To set this feature, see page 22. This feature can also be set using user program No. 20.

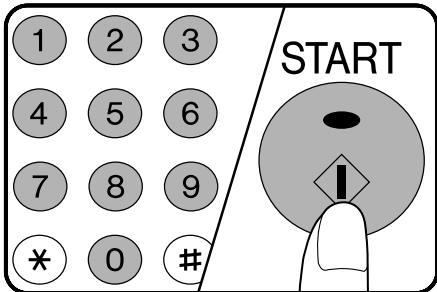

- 3 Set the number of copies and press the START key.**
- To stop a copy run during duplex copying, press the CLEAR (Ⓢ) key.



Note

To cancel the duplex mode, press the ORIGINAL TO COPY key repeatedly until the indicators in the ORIGINAL TO COPY section all go out.

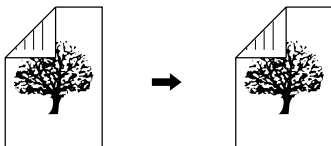

Two-sided copies from two-sided originals

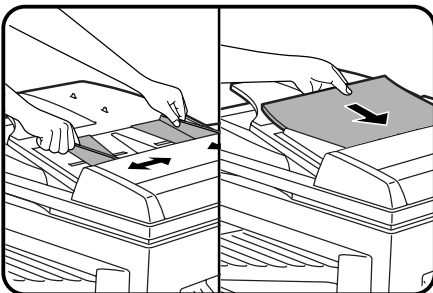

- 1 Ensure that no original is left on the original table. Adjust the original guides to the size of the originals and set the originals face up in the document feeder tray.**

- 5-1/2" x 8-1/2" size original or copy paper cannot be used.

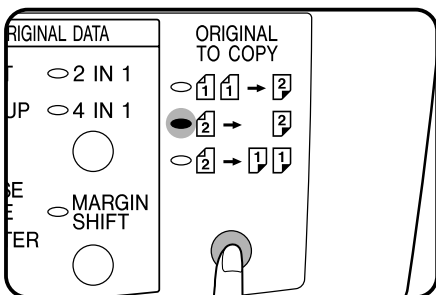

- 2 Use the ORIGINAL TO COPY key to select 1 → 2.**

- When this mode is selected, the RSPF indicator will light up even if no original has been set in the document feeder tray.

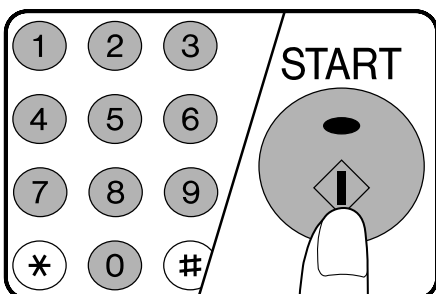

- 3 Set the number of copies and press the START key.**
- Be sure not to touch the originals as they move on the reversing tray. This may cause misfeeds.

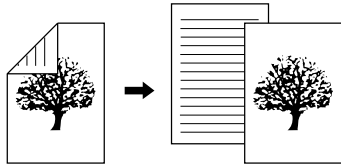

One-sided copies from two-sided originals

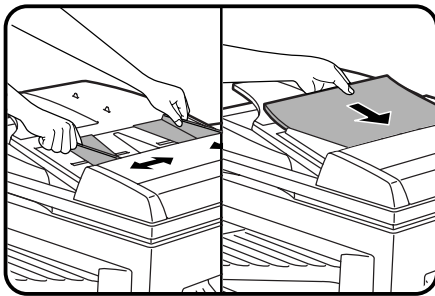

1 Ensure that no original is left on the original table. Adjust the original guides to the size of the originals and set the originals face up in the document feeder tray.

- 5-1/2" x 8-1/2" size original cannot be used.

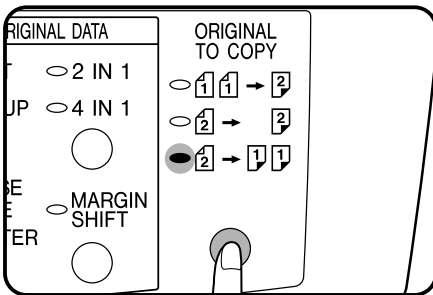

2 Use the ORIGINAL TO COPY key to select **2 → 1 1**.

- When this mode is selected, the RSPF indicator will light up even if no original has been set in the document feeder tray.

Note The image of every front side can be rotated 180° using the image rotation feature. This feature is useful when the originals and copies are in the landscape (horizontal) orientation. To set this feature, see page 22. This feature can also be set using user program No. 20.

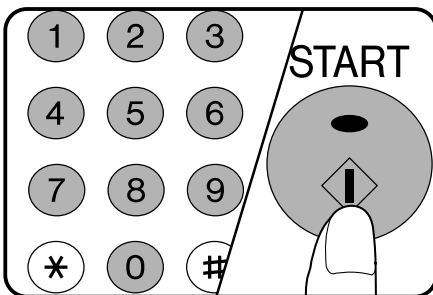

3 Set the number of copies and press the START key.

- Press the CLEAR key to stop copying in the middle of a run.
- Be sure not to touch the originals as they move on the reversing tray. This may cause misfeeds.

COPYING FROM THE ORIGINAL TABLE

Use the original table for copying bound documents and other originals that cannot be set in the RSPF.

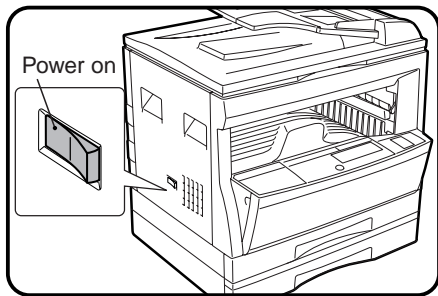

1 Turn the power switch on.

- It will take about 35 seconds for the copier to warm up. However, you can make desired settings and press the START key during warm-up. Copying will start after warm-up.
- If the copier has been programmed in the auditing mode, the START key indicator will not light up and " " will appear in the copy quantity display. Enter an assigned 3-digit account number. See page 13.
- If an optional printer expansion kit or facsimile expansion kit is installed, when the power is already on and all indicators except the POWER SAVE indicator are off, the copier is in the auto power shut-off mode. Press the START key in this case. See page 58, POWER SAVE MODES.

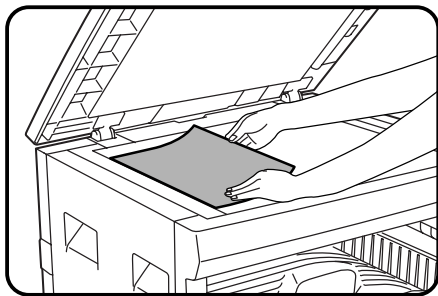

2 Place the original face down on the original table. Align it with the original size scale.

- The ORIGINAL SIZE indicator for the size detected will light up.
- Image loss (max. 5/32" (4 mm)) can occur at the leading and trailing edges of the copies. Also image loss (max. 5/32" (4 mm) in total) can occur along the other edges of the copies.

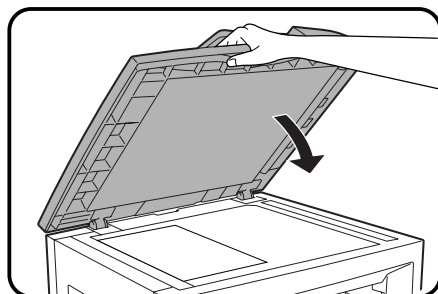

3 Close the document feeder cover.

- Paper matching the size of the original will be automatically selected when the auto paper select function is enabled. To copy onto paper of a different size, press the TRAY SELECT key.
- The auto paper select function can be disabled using user program No. 8. If this function is disabled, use the TRAY SELECT key to select the desired paper tray. See page 51, USER PROGRAMS.
- The bypass tray cannot be automatically selected.

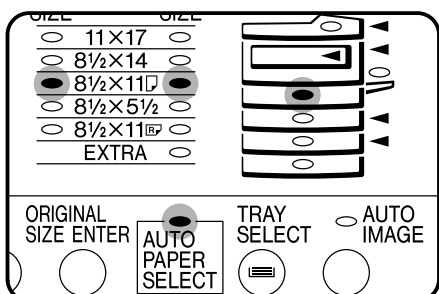

4 Ensure that the desired paper tray is selected.

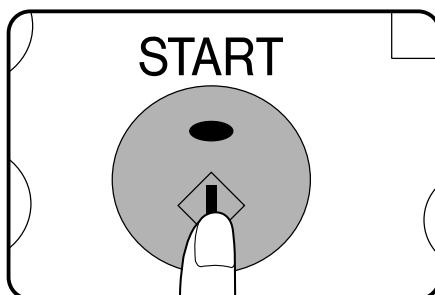
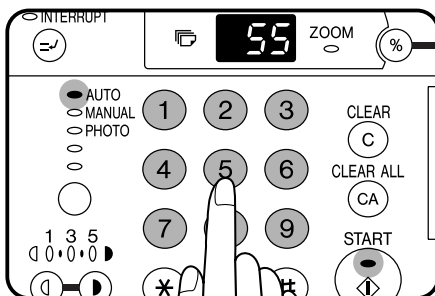
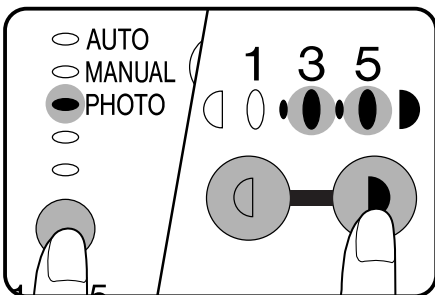
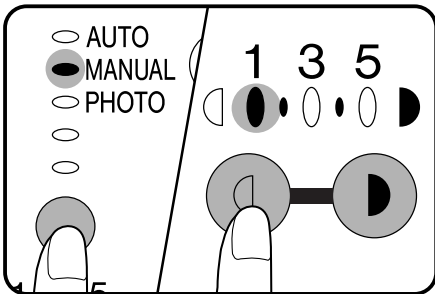
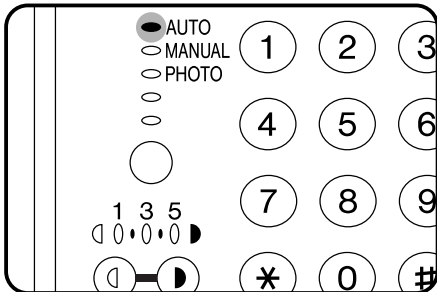

5 Adjust the copy density.

- This copier has three exposure modes to choose from — AUTOMATIC, MANUAL, and PHOTO.
- Automatic exposure is the standard initial setting for this copier. In this mode, the characteristics of the original are “read” by the exposure system and adjustments are automatically made. This optimizes the contrast of the copied images by reducing the effect of colored or shaded background areas. See page 30 to adjust the automatic exposure level.
- For manual copy density adjustment, press the AUTO/MANUAL/PHOTO key to select MANUAL and adjust with the light (D) and dark (D) keys as desired.

- For photographs, select PHOTO and then adjust with the light (D) and dark (D) keys as desired.
- There are 5 exposure steps indicated by 3 indicator lights. (The indicators light up one or two at a time.)
If exposure level 2 is selected, the two left-handmost indicators for that level will light up simultaneously. Also, if level 4 is selected, the two right-handmost indicators for that level will light up simultaneously.

6 Set the number of copies using the numeric keys.

- A single copy can be made with the initial setting, i.e., when “0” is displayed.
- Press the CLEAR (C) key to clear an entry if a mistake is made.

7 Press the START key.

- The number in the copy quantity display will decrease by 1 each time a copy is made.
- Press the CLEAR key to stop copying in the middle of a run.
- To repeat the same copy sequence for a different original, simply replace the original and press the START key.
- If the paper in the selected tray runs out during the copy run and no other tray contains the same size paper, the bypass tray can be selected using the TRAY SELECT key.

Two-sided copies from one-sided originals

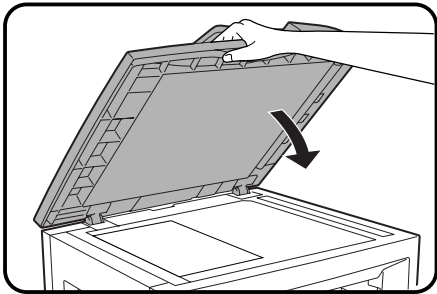

1 Place the first original face down on the original table and close the document feeder cover.

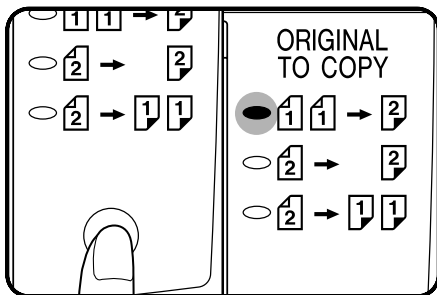

2 Use the ORIGINAL TO COPY key to select $\frac{1}{1} \rightarrow \frac{2}{2}$.

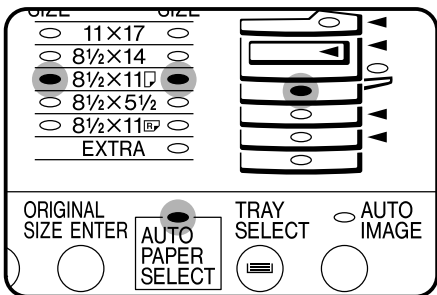

3 Ensure that the desired paper tray is selected.

- Paper sizes that can be used in the duplex mode are 8-1/2" x 11", 8-1/2" x 11"R, 8-1/2" x 14", and 11" x 17".
- 5-1/2" x 8-1/2" size paper cannot be used in the duplex mode.
- The bypass tray cannot be used in the duplex mode.

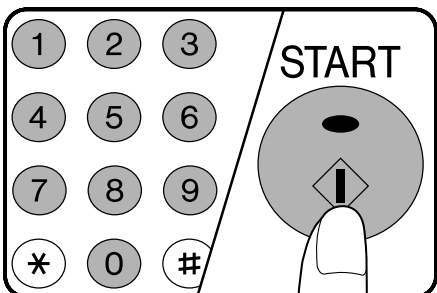

4 Set the number of copies and press the START key.

- The $\frac{1}{1} \rightarrow \frac{2}{2}$ indicator will blink.
- The copy will not be output until both sides have been scanned.

COPYING FROM THE ORIGINAL TABLE

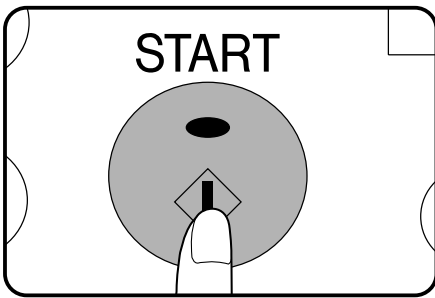

5 Place the second original face down on the original table and press the START key again to copy onto the other side.

- To stop a copy run during duplex copying, press the CLEAR (C) key.
- If an uneven number of originals is set, press the ORIGINAL TO COPY key at the end of the copy run to output the last copy.



Note

- To cancel the duplex mode, press the ORIGINAL TO COPY key repeatedly until the indicators in the ORIGINAL TO COPY section all go out.

- The image of every front side can be rotated 180° using the image rotation feature. This feature is useful when the originals and copies are in the landscape (horizontal) orientation and the two-sided copies are to be read by turning them left to right rather than top to bottom.

To set this feature, follow the procedure below. This feature can also be set using user program No. 20.

Setting image rotation in duplex copying

1 Press and hold down the ORIGINAL TO COPY key for approximately 5 seconds until the 1 1 → 2 indicator will blink and the currently selected parameter number will blink in the copy quantity display.

2 Select the desired parameter using the numeric keys.

- 0: OFF 1: ON
- The factory default setting is 0.

3 Press the START key.

- The selected parameter will be steadily lit.

4 Press the ORIGINAL TO COPY key.

- The 2 → 1 1 indicator will stop blinking.



Note

The image rotation in duplex copying can be also set using user program No. 20. See page 51.

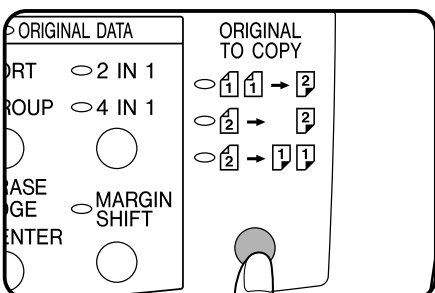
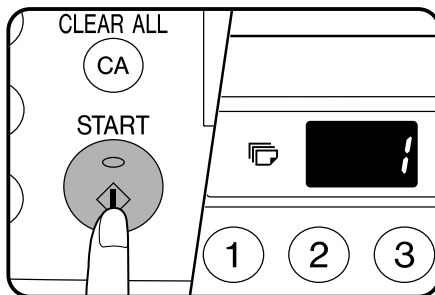
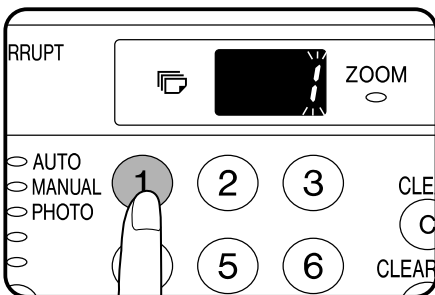
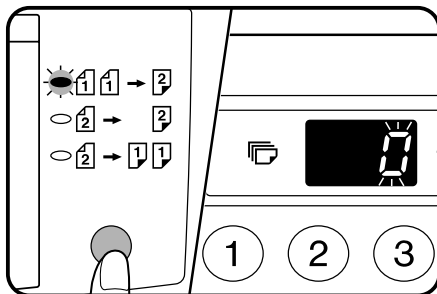

REDUCTION/ENLARGEMENT/ZOOM

Reduction and enlargement ratios can be selected either automatically with the AUTO IMAGE key or manually with the PRESET RATIO selector (⏵, ⏴) keys and/or the zoom (⏴, ⏵) keys. The zoom function enables precise copy ratio selection from 50% to 200% in 1% increments.

Automatic

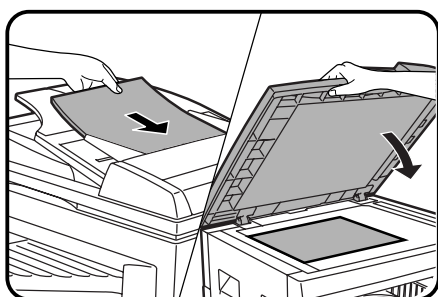

- 1 Place the original in the document feeder tray or on the original table.

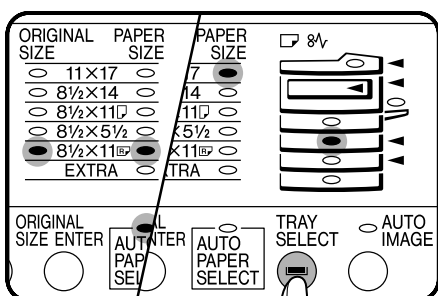

- The ORIGINAL SIZE indicator for the detected size will light up.

- 2 Use the TRAY SELECT key to select the paper tray with the desired paper size.

- This feature will not work when copy paper of non-standard size is used or the bypass tray is used.

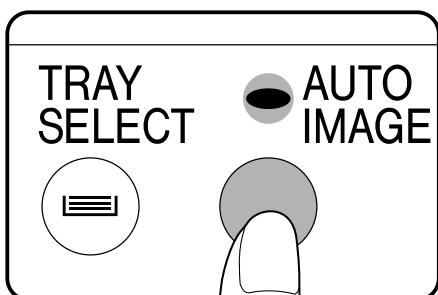

- 3 Press the AUTO IMAGE key.

- The copy ratio will be automatically set.
- If a PRESET RATIO indicator is blinking, part of the original image may not be copied.



Note

- If user program No.7 is not set and the orientation of the original does not correspond to standard reduction/enlargement ratios for the selected paper tray, the ORIGINAL SIZE indicator will blink. Change the orientation of the original.

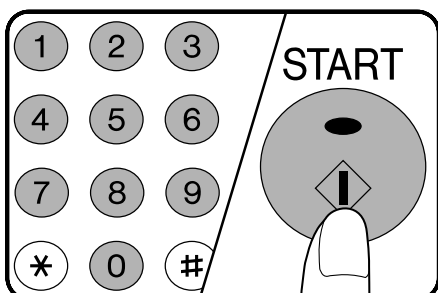

- 4 Set the number of copies.

- 5 Press the START key.



Note

- To cancel the automatic reduction/enlargement mode, press the AUTO IMAGE key again.
- When copying from the RSPF with this feature, the automatic reduction/enlargement mode will be automatically canceled after copying is complete.

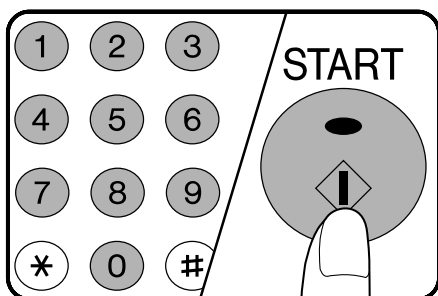
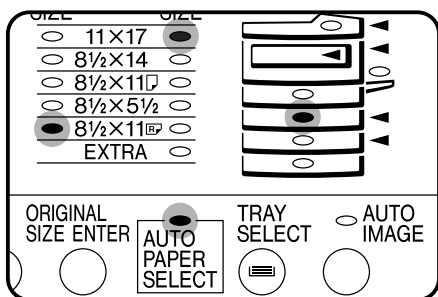
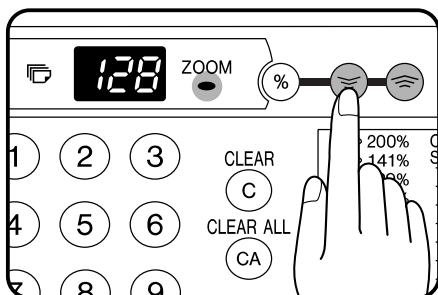
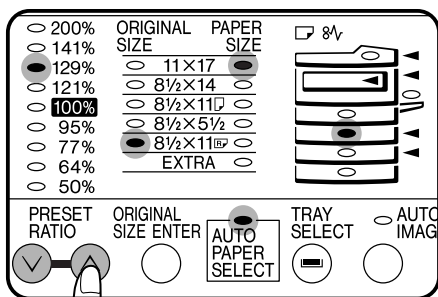
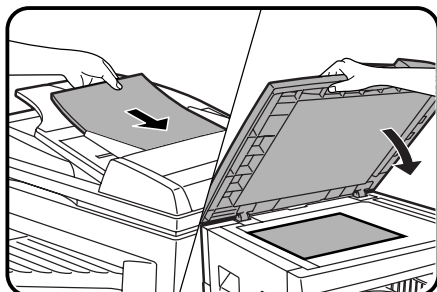

Manual

1 Place the original in the document feeder tray or on the original table.

2 Use the PRESET RATIO selector (⏴, ⏵) keys and the zoom (⏴, ⏵) keys to select the desired copy ratio.

- To select a preset reduction or enlargement copy ratio, press the ⏴ or ⏵ key repeatedly until the indicator for the desired copy ratio is lit.

A. Preset reduction ratios are: 95%, 77%, 64%, and 50% .

B. Preset enlargement ratios are: 121%, 129%, 141%, and 200%.

C. Zoom ratios: Any ratio from 50% to 200% can be set, in 1% increments. Press the ⏴ or ⏵ key to set the approximate ratio, then press the ⏴ key to decrease the ratio or the ⏵ key to increase the ratio.

- When a zoom (⏴, ⏵) key is pressed, the ZOOM indicator will light up and the zoom ratio will be displayed in the copy quantity display for at least two seconds.

- To verify a zoom setting without changing the zoom ratio, press and hold down the copy ratio display (Ⓢ) key. When the key is released, the display will return to the copy quantity display.

- To decrease or increase the zoom ratio rapidly, press and hold down the ⏴ or ⏵ key. However the value will stop at the preset reduction or enlargement ratios. To move beyond these ratios, release the key and then press and hold it down again.

D. Same-size reset: Press the ⏴ or ⏵ key repeatedly until the copy ratio returns to 100%.

3 Ensure that the desired paper tray is selected.

- If the auto paper select function has been enabled, the appropriate copy paper size will have been automatically selected based on the original size and the selected copy ratio. If the selected PRESET RATIO indicator or the ZOOM indicator blinks, the selected copy image is too large for the copy paper size.

- If the auto paper select function has been disabled or if copying onto a different size paper, use the TRAY SELECT key to select the paper feed station with the desired paper size.

4 Set the number of copies and press the START key.

BYPASS FEED (special paper)

The bypass tray is used to copy onto transparency film, labels, and other special purpose papers. Up to 100 sheets of standard copy paper can be set in the bypass tray.



Note

For special purpose papers, the original image must be smaller than the paper or media for copying. If the original image is bigger than the paper or media, this may cause smudges on the edges of the copies. Also for standard copy paper, smudges may appear if the copy paper is not at least as large as the original image.

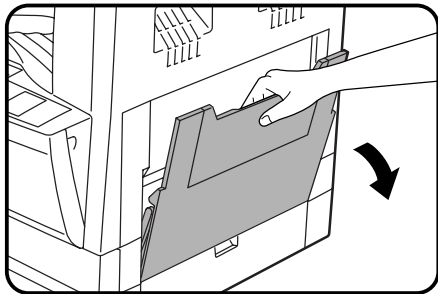

1 Unfold the bypass tray.

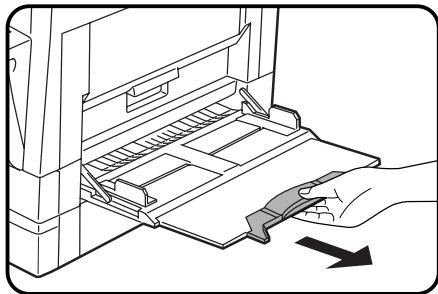

- When feeding 8-1/2" x 14" or 11" x 17" sized paper, extend the bypass tray.

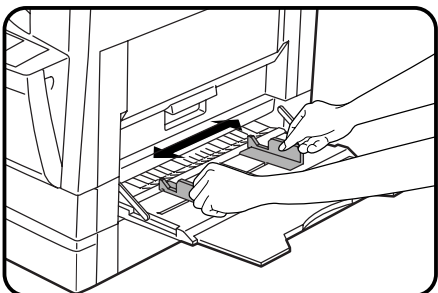

2 Set the paper guides to the copy paper width.

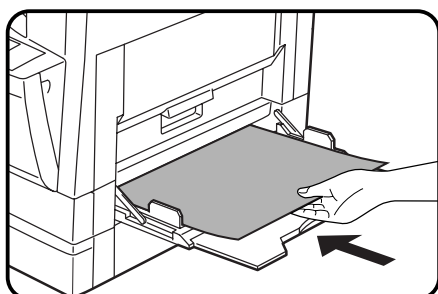

3 Insert the copy paper (print face down) all the way into the bypass tray.

- Up to 100 sheets of standard copy paper measuring from 5-1/2" x 8-1/2" to 11" x 17" can be loaded in the bypass tray.
- Transparency film, labels, and other special purpose papers (except envelopes) must be fed individually. Up to 10 envelopes can be set.
- When adding paper, first remove remaining paper, combine it with the paper to be added and then reload as a single stack.
- When loading envelopes, make sure that they are straight and flat.

BYPASS FEED (special paper)

MAKING COPIES

Bypass feed (special paper)

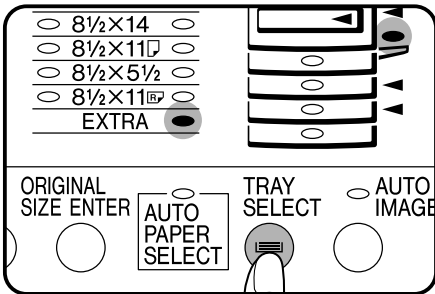

4 Press the TRAY SELECT key to select the bypass tray.

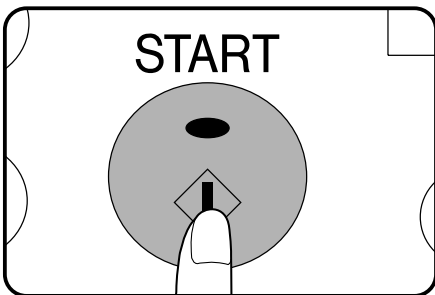

5 Leave the copy quantity at 0 if using special papers. Set the number of copies if using standard copy paper or envelopes.

6 Press the START key.

SORT/GROUP

This copier has two sorter modes for different copying jobs: one sorts copies into sets matching the sequence of the originals and the second groups copies by originals.

The sort/group feature cannot be used with the dual page copy feature.

To change the SORT/GROUP mode, press the SORT/GROUP key to select the desired mode.

- The capacity of the paper output tray is 250 sheets (150 sheets if an optional job separator tray kit (AR-TR2) is installed). When the number of copies output reaches this limit in a sort or a group copy run, copying will stop, the output tray full () indicator will light and the START key indicator will blink.

Remove the copies from the paper output tray and press the START key to resume copying.

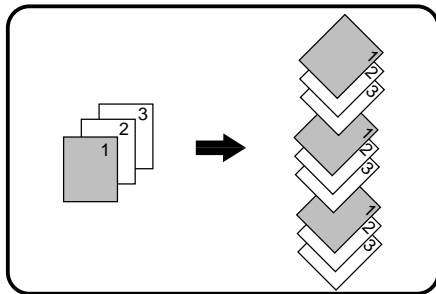

Sort mode

Each set of copies will be sequentially delivered to the paper output tray.

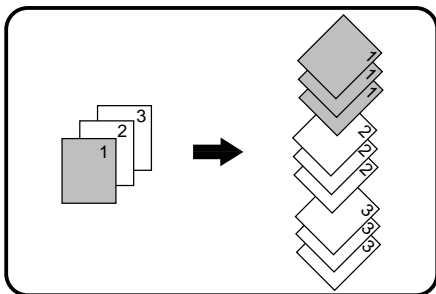

Group mode

All copies of the same originals will be grouped in the paper output tray.

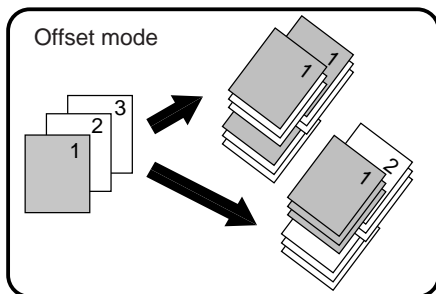

Offset stack

If the offset stack mode is enabled using user program No. 19, each copy will be offset by approximately 1 inch (25 mm). When copying in the sort mode, each collated set of copies will be stacked offset from the previous set. When copying in the group mode, copies will be offset and stacked in groups of multiple copies from the same original.

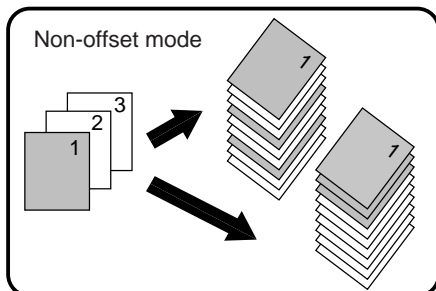

If the offset stack mode is disabled, copies will not be offset.

The offset stack mode is enabled in the factory default setting.

Copying in the sort mode

When copying in the sort mode, the original image will be stored in the copier memory each time an original is scanned and copying will start after all originals have been scanned.

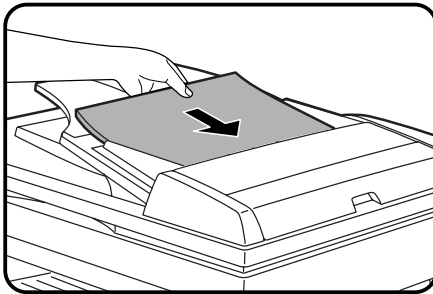

- 1 Set the originals face up in the document feeder tray.
 - The original table cannot be used for sort copying.

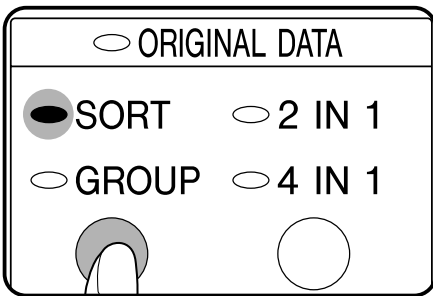

- 2 Press the SORT/GROUP key to select the SORT mode.

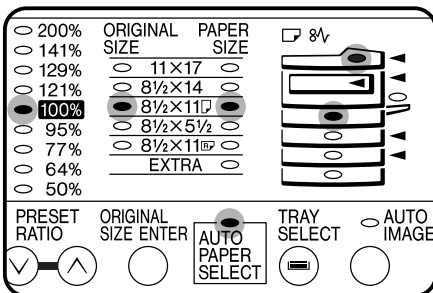

- 3 Ensure that the desired copy paper size is selected.

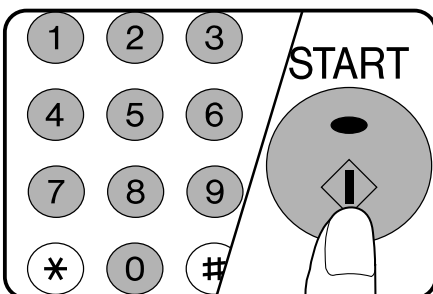

- 4 Set the number of copies and press the START key.
 - Copying will start after the originals have been scanned. Up to 30 sheets of originals can be scanned. (If originals are fed continuously using the stream feeding mode, up to approximately 60 sheets of 8-1/2" x 11" originals can be scanned. However, when copying originals which require more memory such as photographs, the number of originals which can be scanned will be less.) When the memory becomes full of scanned original image data, the ORIGINAL DATA indicator will blink. When the ORIGINAL DATA indicator blinks, the copier will stop scanning. To start copying of scanned originals, press the START key. To cancel copying, press the CLEAR or CLEAR ALL key.

INTERRUPTING A COPY RUN

INTERRUPT is used to interrupt a long copy run so that another job can be done.

- SORT or GROUP cannot be selected during interrupt copying.
- INTERRUPT will not function during two-sided copying.
- Two-sided copying cannot be performed during INTERRUPT copying.

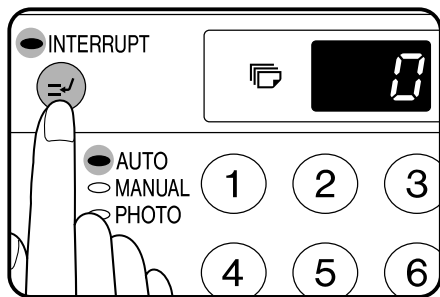

1 Press the INTERRUPT key.

- The copier will return to the initial settings.
- If this copier has been programmed in the auditing mode using user program No. 10, “ ” will appear in the copy quantity display. Enter your account number using the numeric keys. The number of copies of the interrupt copying will be accumulated against this account number. See page 13.
- When the RSPF is being used, the copier will stop after completing the copying of the original which has been fed into the RSPF.

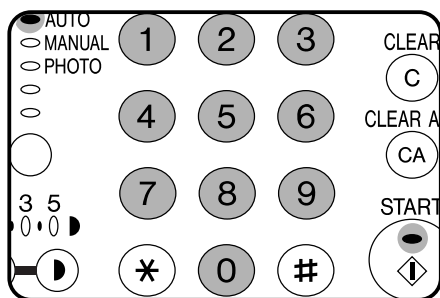

2 When the copier stops, remove the original(s) and set the original(s) for interrupt copying.

3 Select the desired available copier functions.

4 Set the number of copies.

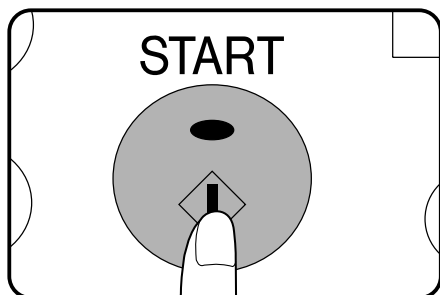

5 Press the START key.

- The interrupt copies will be offset from the previous copies when user program No. 19 is enabled. See page 51.

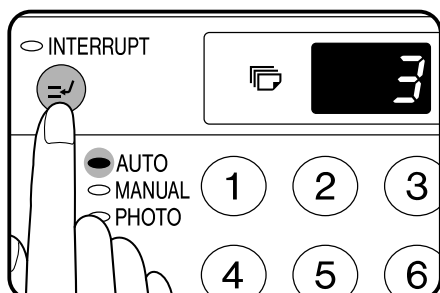

6 When all INTERRUPT copies are finished, press the INTERRUPT key again to cancel the INTERRUPT mode, and remove the original used for interrupt copying.

- The previous copy quantity, copy ratio, copy density, and paper size will be automatically restored.

7 Replace the original for the interrupted job and press the START key to resume copying.

AUTOMATIC EXPOSURE ADJUSTMENT

The automatic exposure level can be adjusted to suit your copying needs. This level is set for copying from the original table and copying from the RSPF respectively. To set the level for the RSPF, place an original in the document feeder tray and make sure that the RSPF indicator lights up before proceeding to step 1. To set the level for the original table, ensure that the RSPF indicator does not light up.

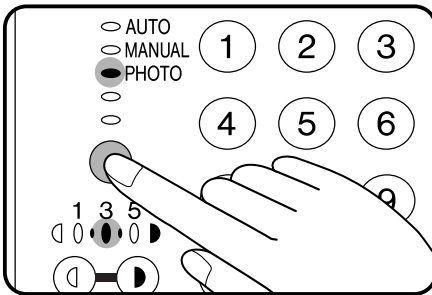

1 Press the AUTO/MANUAL/PHOTO key to select the PHOTO mode.

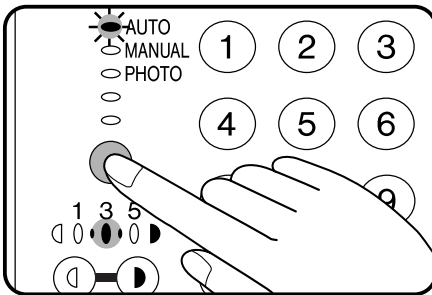

2 Press and hold down the AUTO/MANUAL/PHOTO key for approximately 5 seconds.

- The PHOTO indicator will go out and the AUTO indicator will begin to blink.
- One or two exposure indicators corresponding to the current automatic exposure level will light up. The factory default setting is level “3”.

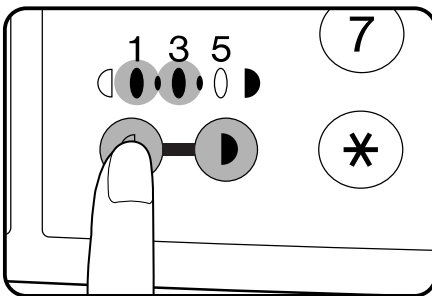

3 Press the light (☉) or dark (◐) key to lighten or darken the automatic exposure level as desired.

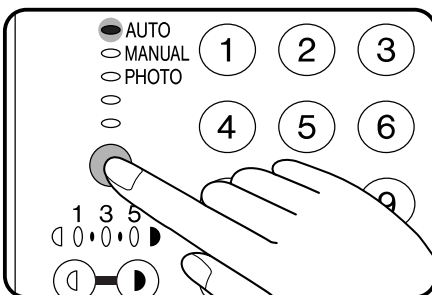

4 Press the AUTO/MANUAL/PHOTO key.

- The AUTO indicator will stop blinking and will light up steadily.
- This automatic exposure level will remain in effect until you change it again by this procedure.

TONER SAVE MODE

This mode reduces toner consumption by approximately 10% in the automatic and manual exposure modes. Copies will be lighter but still adequate for general use. Selection of this mode does not affect the PHOTO mode. Follow the procedure below for setting the toning level.

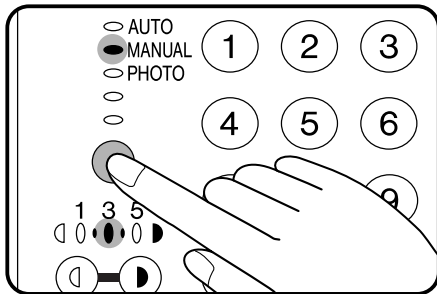

- 1** Press the AUTO/MANUAL/PHOTO key to select the MANUAL mode.

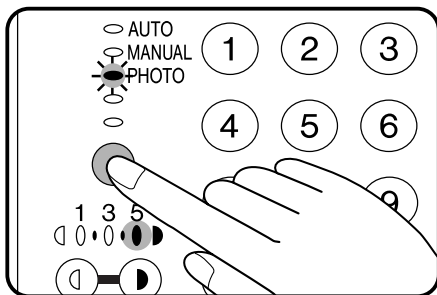

- 2** Press and hold down the AUTO/MANUAL/PHOTO key for approximately 5 seconds.

- The MANUAL indicator will go out and the PHOTO indicator will begin to blink.
- The exposure indicator marked “5” will light up, indicating that the standard toner mode is active.

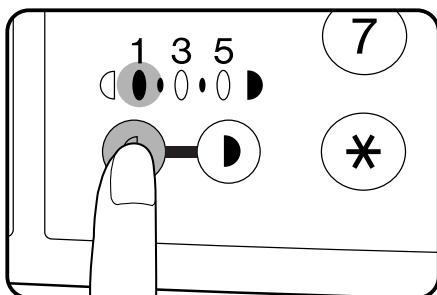

- 3** To enter the toner save mode, press the light (☺) key.

- The exposure indicator marked “1” will light up, indicating that the toner save mode is selected.

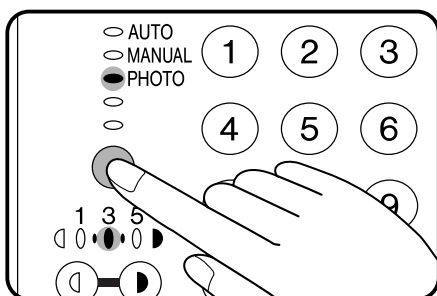

- 4** Press the AUTO/MANUAL/PHOTO key.

- The PHOTO indicator will stop blinking and will light up steadily. The toner save mode is now active.
- To return to the standard mode, repeat the procedure but use the dark (☹) key to select exposure level “5” in step 3.

XY ZOOM

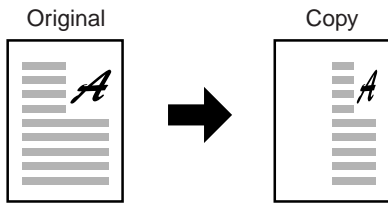

The XY ZOOM feature allows the horizontal and vertical copy ratios to be changed independently. This feature cannot be used with the 2 in 1 or 4 in 1 feature.

To use the XY ZOOM feature with the DUAL PAGE COPY feature, set the DUAL PAGE COPY feature first and then the XY ZOOM feature. (Enlargement cannot be set.)

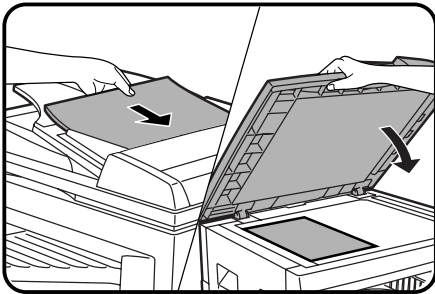

1 Place the original in the document feeder tray or on the original table.

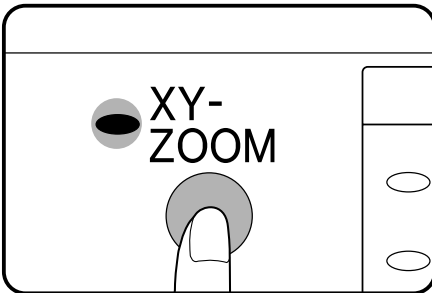

2 Press the XY-ZOOM key.

- The current value for the vertical direction will be displayed in the copy quantity display.

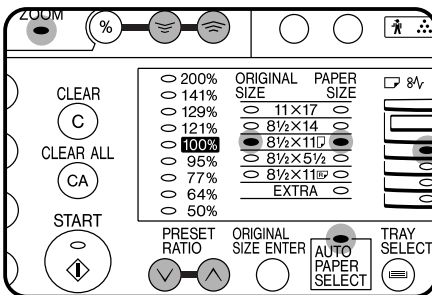

3 Use the PRESET RATIO selector (↓, ↑) keys and zoom (⊖, ⊕) keys to change the copy ratio in the vertical direction.

- Press a PRESET RATIO selector (↓ or ↑) key to set an approximate ratio, then press the ⊖ key to decrease the ratio or ⊕ key to increase the ratio. The copy ratio will be displayed in the copy quantity display.

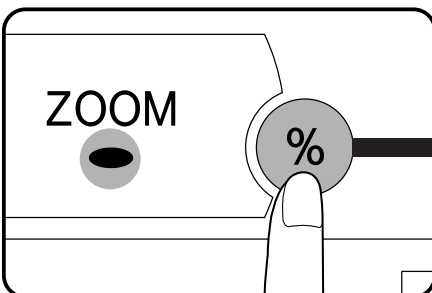

4 Press the copy ratio display (Ⓢ) key.

- The selected ratio for the vertical direction will be entered and the current value for the horizontal direction will be displayed in the copy quantity display.

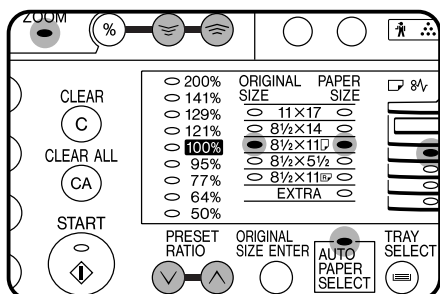

5 Use the PRESET RATIO selector (∇ , \blacktriangle) keys and zoom (\leftarrow , \rightarrow) keys to change the copy ratio in the horizontal direction in a similar manner as for the vertical direction.

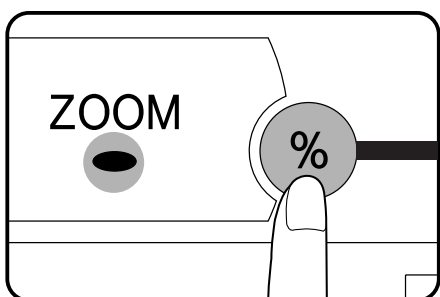

6 Press the copy ratio display ($\%$) key.

- The selected ratio for the horizontal direction will be entered and the display will change to the copy quantity display.
- To verify the copy ratios, press and hold down the copy ratio display ($\%$) key. The vertical and horizontal ratios will be alternately displayed.

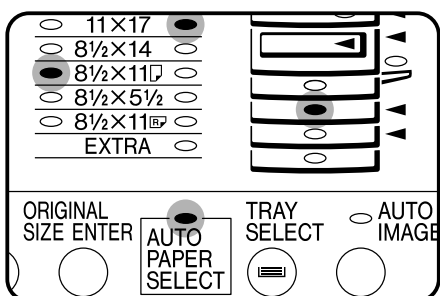

7 Ensure that the desired paper tray is selected.

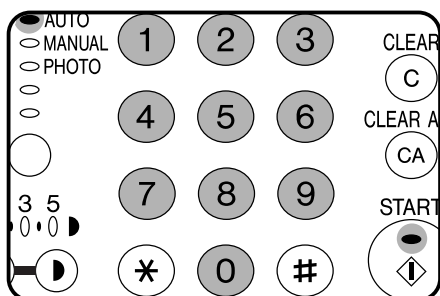

8 Set the number of copies.

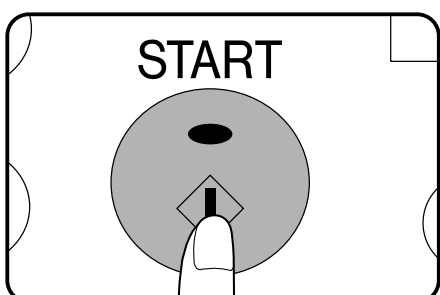

9 Press the START key.

 Note

- To change the copy ratios again, press a PRESET RATIO selector (∇ , \blacktriangle) key or a zoom (\leftarrow , \rightarrow) key. Then, perform step 3 and the succeeding steps.
- To cancel this function, press the XY-ZOOM key again.

SPECIAL FEATURES
XY ZOOM

B/W REVERSE

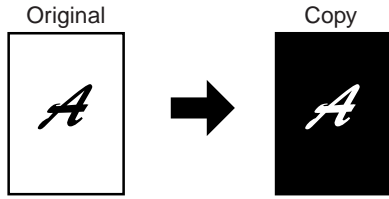

The B/W REVERSE feature is used to reverse black and white areas.

- When the B/W REVERSE feature is selected, the exposure mode will be automatically set to the MANUAL mode. Other exposure modes cannot be selected. Even if this feature is canceled, the MANUAL mode will not automatically be canceled.

SPECIAL FEATURES

B/W reverse



- 1 Place the original in the document feeder tray or on the original table.

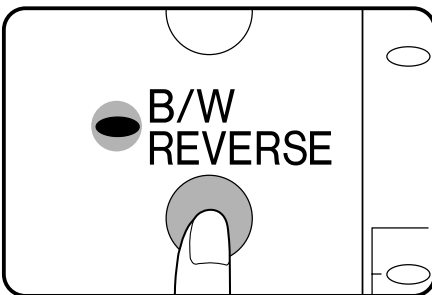

- 2 Press the B/W REVERSE key.

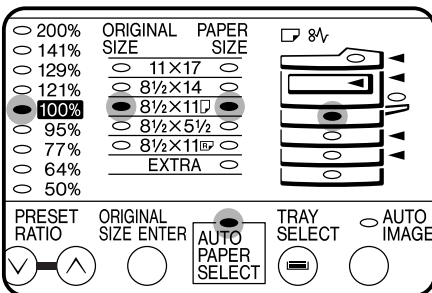

- 3 Ensure that the desired paper tray is selected.

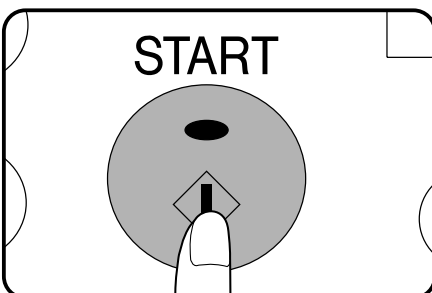

- 4 Make all other desired copier selections and press the START key.

DUAL PAGE COPY

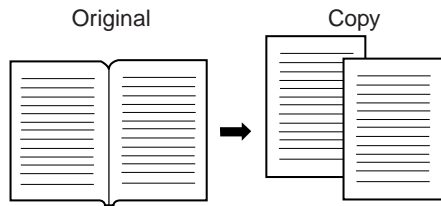

The DUAL PAGE COPY feature produces individual copies of two documents placed side by side on the original table. It is especially useful when copying books and other bound documents. This feature cannot be used with the 2 in 1 or 4 in 1 feature and sort/group feature. If the AUTO IMAGE feature has been selected, this feature cannot be selected. To use the DUAL PAGE COPY feature with the XY ZOOM feature, set the DUAL PAGE COPY feature first and then the XY ZOOM feature. (Enlargement cannot be set.)

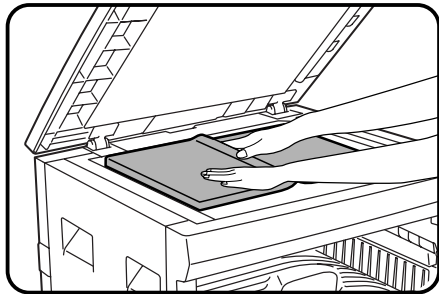

1 Place the originals on the original table with the center of the two pages aligned with the paper size index ( 8½). Close the document feeder cover.

- Set the page to be copied first to the right of the paper size index mark.

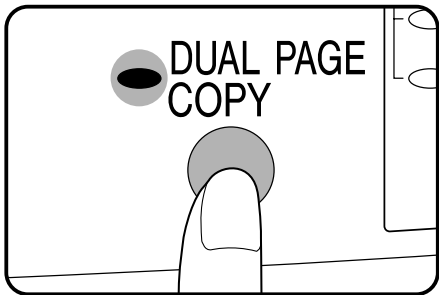

2 Press the DUAL PAGE COPY key.

- Check to be sure that 8-1/2" x 11" sized paper is selected.

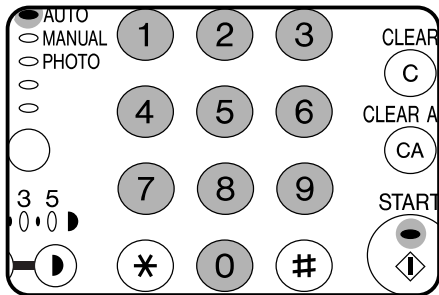

3 Set the number of copies.

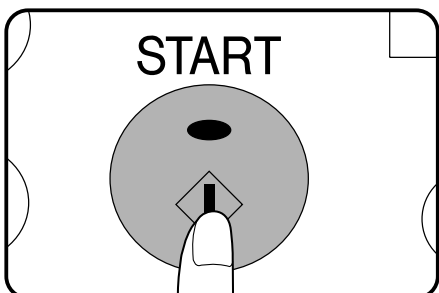

4 Press the START key.

ROTATION COPYING

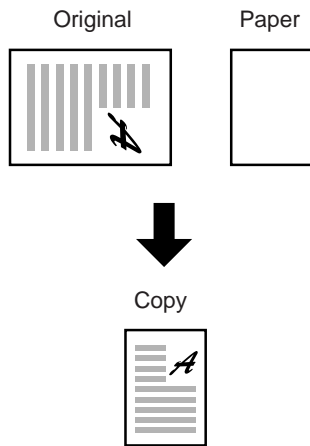

If user program No. 7 is set, the image of the original will rotate when the orientation of the original does not match that of the copy paper. Rotation copying will function only if the AUTO PAPER SELECT mode or AUTO IMAGE mode has been selected. Even if user program No. 7 is not set, rotation copying will function when the 2 in 1 or 4 in 1 function is selected. See page 51. However, if enlargement copying onto a paper size larger than 8-1/2" x 11" is performed, the image cannot be rotated.

When this occurs, the detected size and orientation of the original will be indicated by a steadily lighted indicator and a flashing indicator will show the required orientation of the original. The original must be rotated 90° to match the flashing indicator to prevent image loss on the copies.

Example: Copying from an 11" x 17" original
onto 8-1/2" x 11" paper

2 IN 1 OR 4 IN 1

2 in 1 copying

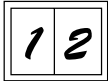

Pattern ①



Pattern ②

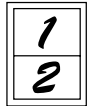

Pattern ①



Pattern ②

4 in 1 copying

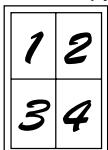

Pattern ①

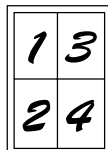

Pattern ②

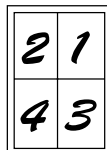

Pattern ③

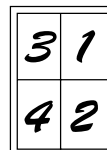

Pattern ④

The 2 in 1 or 4 in 1 feature is used to copy 2 or 4 originals, collectively in a specified order, onto one sheet.

- These features cannot be used with the dual page copying, XY zoom, erase, or margin shift features.
- Copies can be made with or without the border lines shown in the illustration. See user program No. 6 on page 51.
- The order of originals which will be arranged on the copies can be selected by user programs. There are two patterns of layout for 2 in 1 copying and four patterns of layout for 4 in 1 copying. See user program No. 17 and 18 on page 51.
- The 2 in 1 or 4 in 1 feature operates only in the sort or group mode. If the 2 in 1 or 4 in 1 feature is selected when either the sort or group mode has not been selected, the group mode will be automatically selected.

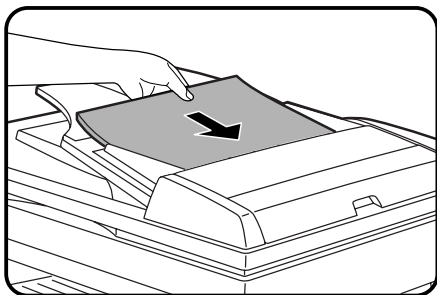

1 Set the originals face up in the document feeder tray.

- The original table cannot be used for the 2 in 1 or 4 in 1 feature.

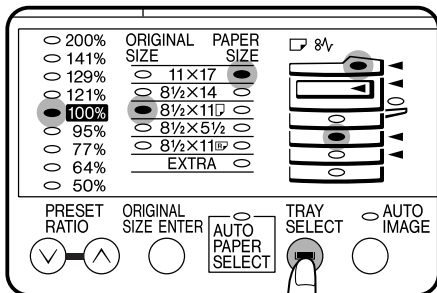

2 Use the TRAY SELECT key to select the paper tray with the desired paper size.

- The bypass tray and any tray with non-standard size paper cannot be used with the 2 in 1 or 4 in 1 feature.

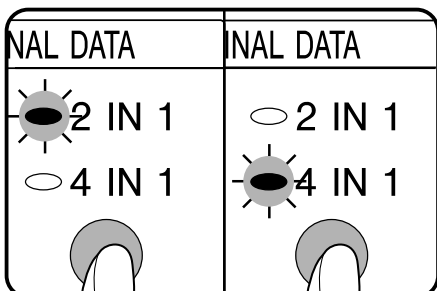

3 To confirm or set the layout pattern for 2 in 1 copying, first ensure that both the 2 IN 1 and 4 IN 1 indicators are not lit then press and hold the 2 IN 1 / 4 IN 1 key for more than 5 seconds.

- The 2 IN 1 indicator will blink and the currently selected layout pattern number will blink in the copy quantity display.

To confirm or set the layout pattern for 4 in 1 copying, use the 2 IN 1 / 4 IN 1 key to light the 2 IN 1 indicator then press and hold the 2 IN 1 / 4 IN 1 key for more than 5 seconds.

- The 4 IN 1 indicator will blink and the currently selected layout pattern number will blink in the copy quantity display.

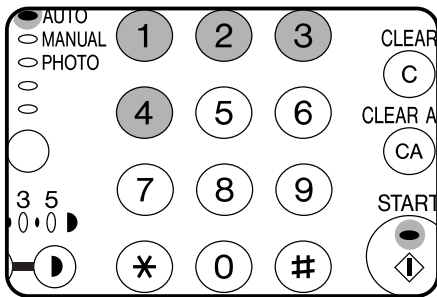

- 4 Enter the desired pattern number using a numeric key.**
- The entered number will blink in the copy quantity display. For layout pattern numbers, see the previous page.

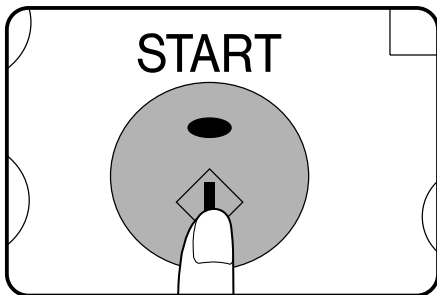

- 5 Press the START key.**
- The entered number will light up steadily.
- 6 Press the 2 IN 1 / 4 IN 1 key to complete the selection.**
- The copy ratio will be calculated automatically. If the calculated copy ratio is less than 50%, part of original image may not be copied because the smallest copy ratio is 50%.

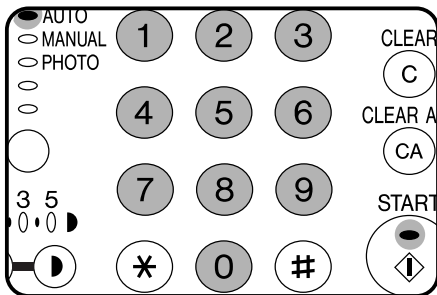

- 7 Set the number of copies.**

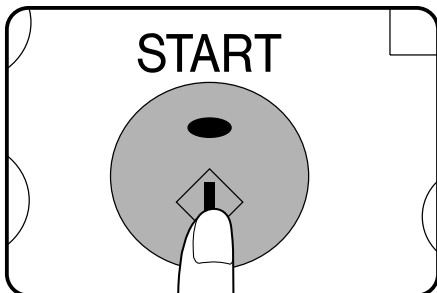

- 8 Press the START key.**
- Copying will start after the originals have been scanned. Up to 30 sheets of originals can be scanned. (If originals are fed continuously using the stream feeding mode, up to approximately 60 sheets of 8-1/2" x 11" originals can be scanned. However, when copying originals which require more memory such as photographs, the number of originals which can be scanned will be less.) When the memory becomes full of scanned original image data, the ORIGINAL DATA indicator will blink. When the ORIGINAL DATA indicator blinks, the copier will stop scanning. To start copying of scanned originals, press the START key. To cancel copying, press the CLEAR or CLEAR ALL key.

ERASE

Edge erase

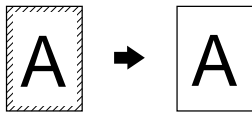

Center erase

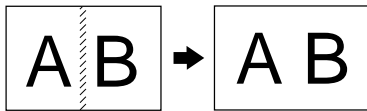

Edge + Center erase

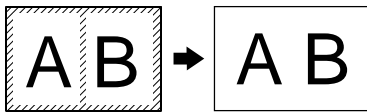

This copier has an edge erase mode and a center erase mode.

- Edge erase can be used to eliminate shadow lines around the edges of copies caused when thick paper or a book is used as an original.
- Center erase can be used to eliminate the shadow produced by the bindings of bound documents.
- Edge + center erase can be used to eliminate shadow lines around the edges of copies and to eliminate the shadow at the center of copies.
- The erase width can be set from 0" to 1" in five steps using user program No. 16. See page 51.
- This feature cannot be used with the 2 in 1 or 4 in 1 feature.

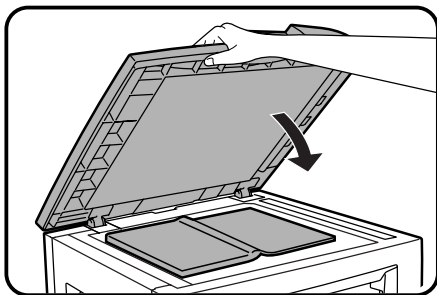

1 Place the original on the original table and close the document feeder cover.

- The RSPF can also be used for this feature.

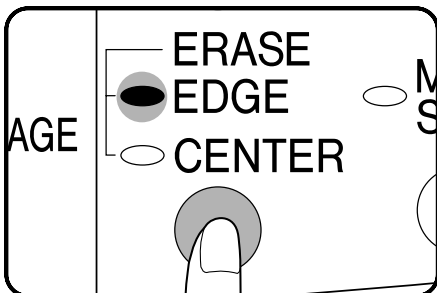

2 Press the ERASE key to select the desired erase mode.

- To select the EDGE + CENTER ERASE mode, press the ERASE key until both the EDGE and CENTER indicators light up.

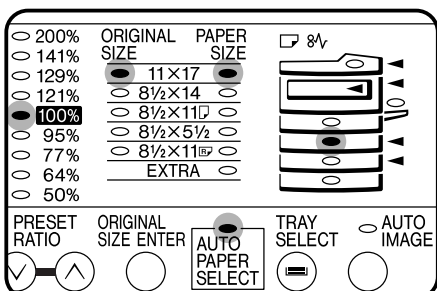

3 Ensure that the desired copy paper size is selected.

- The bypass tray and any tray with non-standard size paper cannot be used for this feature.

ERASE

SPECIAL FEATURES Erase

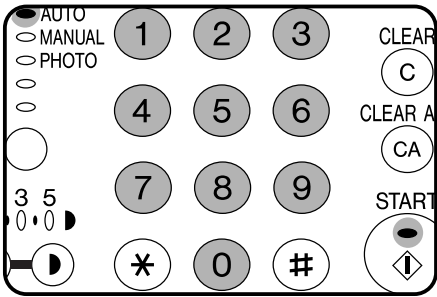

4 Set the number of copies.

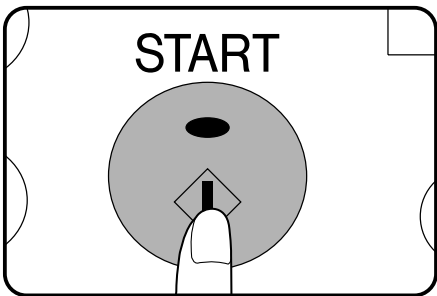

5 Press the START key.

MARGIN SHIFT

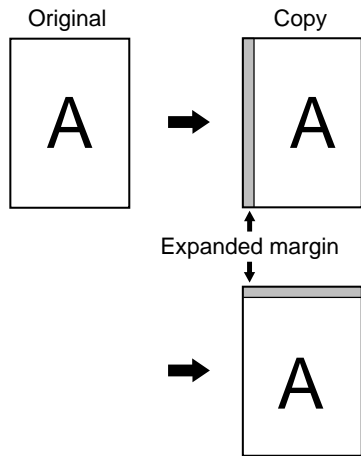

The MARGIN SHIFT feature automatically shifts the text or image to increase the margin by approximately 1/4".

- The location of the margin to be increased can be selected to be either at the left edge or the top of the page. To select the location, see step 2 below.
- This feature cannot be used with the 2 in 1 or 4 in 1 feature.

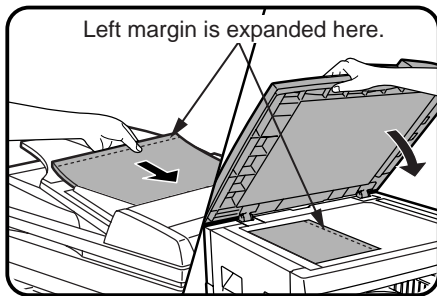

1 Place the original in the document feeder tray or on the original table.

- When copying from the original table and the margin is to be increased on the left side, set the original face down so that the margin side is positioned at the right side.
- If top is selected, set the margin to be expanded to the rear side of the original table or the document feeder tray.

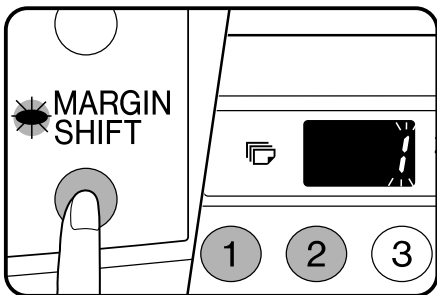

2 To confirm or set the location of the margin, press and hold the MARGIN SHIFT key for approximately 5 seconds until the MARGIN SHIFT indicator will blink.

- The currently selected number of the margin location will blink in the copy quantity display.

1: Left 2: Top

Select the desired parameter using the numeric keys, and press the START key.

- The selected parameter will be steadily lit.

Press the MARGIN SHIFT key.

- The MARGIN SHIFT indicator will stop blinking.

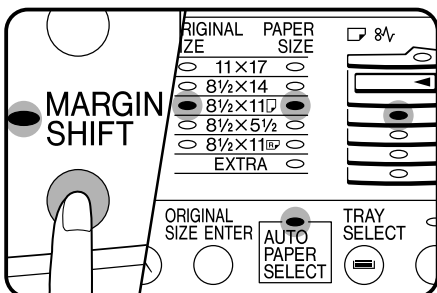

 The location of the margin can be also set using user program No. 22. See page 51.

3 Press the MARGIN SHIFT key and ensure that the desired copy paper size is selected.

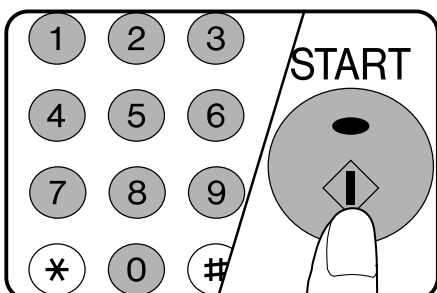

4 Set the number of copies and press the START key .

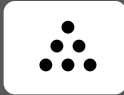

TONER CARTRIDGE REPLACEMENT

When the toner cartridge replacement required (⋯) indicator lights up, replacement of the toner cartridge will be needed soon. Obtain a new cartridge. When the toner cartridge replacement required (⋯) indicator blinks, the toner cartridge must be replaced before copying can be resumed. Replace the toner cartridge by following the procedure below.

For best copying results, be sure to use only SHARP Genuine Supplies which are designed, engineered and tested to maximize the life and performance of SHARP copiers. Look for the Genuine Supplies label on the toner package.



Note

During a long copy run of a dark original, the ⋯ indicator may blink and the copier stop, even though toner is left. The copier will feed toner up to 2 minutes and then the START key indicator will light up. Press the START key to restart copying.

SHARP

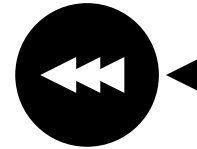

GENUINE SUPPLIES

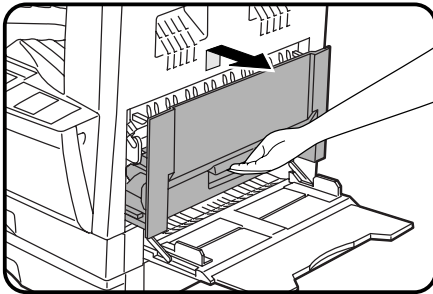

- 1 Open the bypass tray. Lift slightly on the side cover and slide the cover out until it stops.

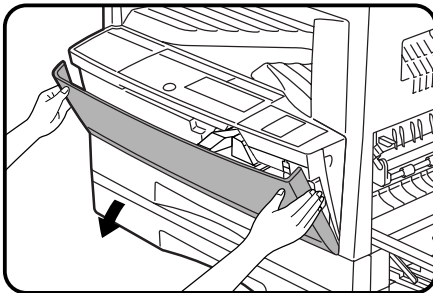

- 2 Push gently on both sides of the front cover to open the cover.

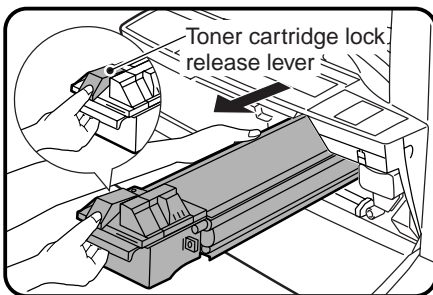

- 3 Push the toner cartridge lock release lever and pull the toner cartridge out. Remove the toner cartridge while supporting it with the left hand at the green label position.

- For disposal of the old toner cartridge, contact your dealer.

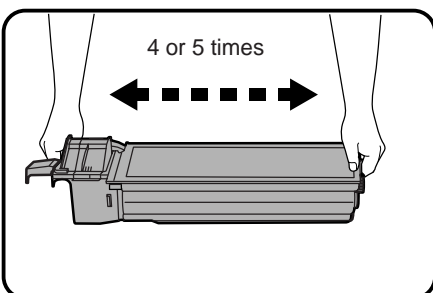

- 4 Remove the new toner cartridge from the bag. Hold the cartridge on both sides and shake it horizontally four or five times.

STATUS INDICATORS

⋯ Toner cartridge replacement

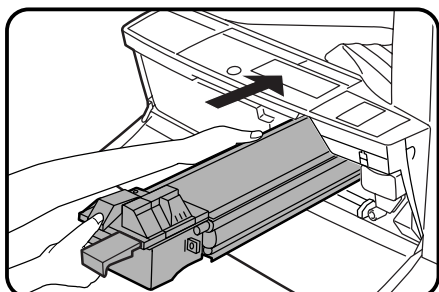

5 Gently insert the toner cartridge along the guides until it locks in place while pushing the lock release lever.



Note

If dirt or dust is adhered to the toner cartridge, remove it before installing the cartridge.

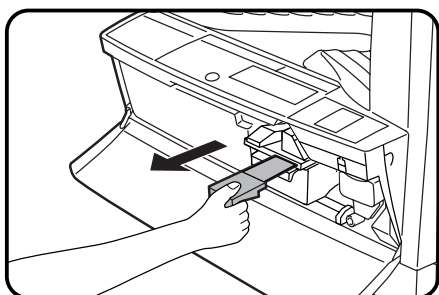

6 Pull out the shutter and remove it from the toner cartridge as shown in the illustration.

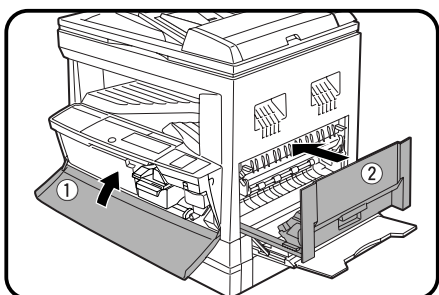

7 Close the front cover by pushing both sides with your hands and then close the side cover by pressing the handle on the cover. The \odot indicator will go out.



Caution

When closing the covers, be sure to close the front cover securely and then close the side cover. If the covers are closed in the wrong order, the covers may be damaged.

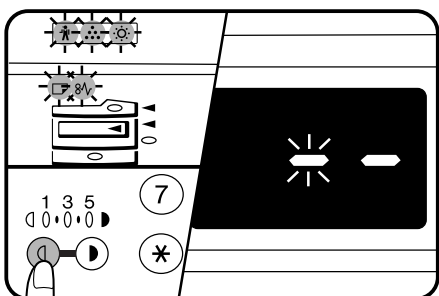

Toner cartridge life

To find out the approximate quantity of toner remaining, follow the procedure below.

1 Press and hold the light (Ⓛ) key for more than 5 seconds until all the alarm indicators (Ⓜ , ⚠ , ⦿ , Ⓚ , and ⚡) blink and "-" appears in the copy quantity display.

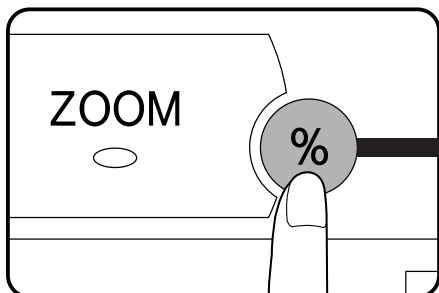

2 Press and hold the copy ratio display (Ⓢ) key for more than 5 seconds.

- The approximate quantity of toner remaining will be indicated as a percent in the copy quantity display. If "LO" is displayed, the toner is down to less than 10%.

3 Press the light (Ⓛ) key.

- All the alarm indicators will go out.



MISFEED REMOVAL

The copier will stop when a misfeed occurs. The misfeed (⚡) indicator will blink, and blinking red misfeed location indicators will indicate the approximate misfeed location.

If paper is accidentally torn during removal, be sure to remove all pieces.

Be careful not to damage the photoconductive drum.

For misfeeds in optional equipment, see their respective sections of the operation manual.

First confirm the misfeed location.

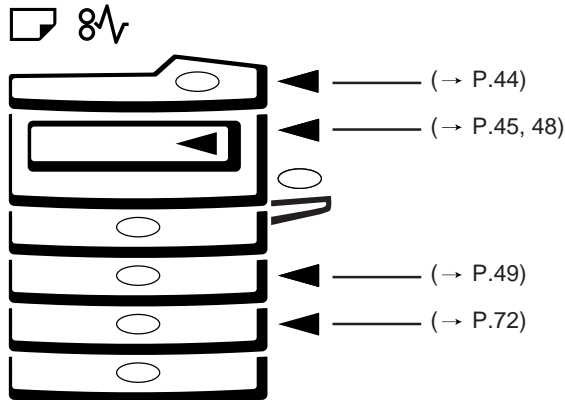

Misfeed in the RSPF

If an original misfeed occurs in the RSPF, the copier will stop and the red indicator which indicates an original misfeed will blink.

STATUS INDICATORS

⚡ Misfeed removal

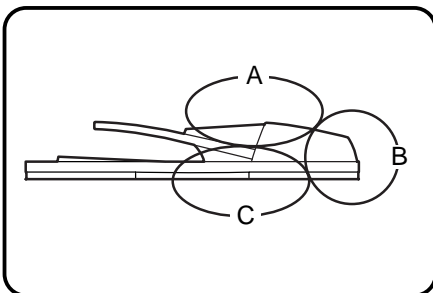

Location A

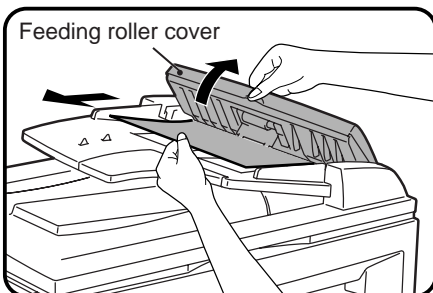

1 Open the feeding roller cover and pull the original gently to the left and out from the document feeder tray. Close the feeding roller cover.

Location B

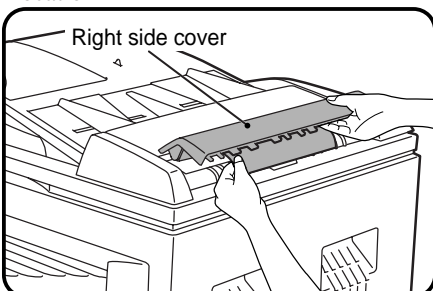

2 If the misfed original cannot be removed in step 1, open the right side cover and remove the misfed original. Close the right side cover.

Location C

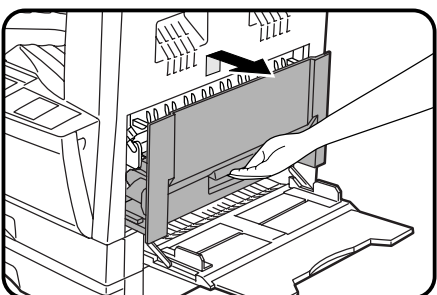
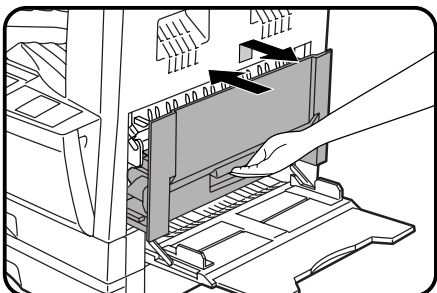
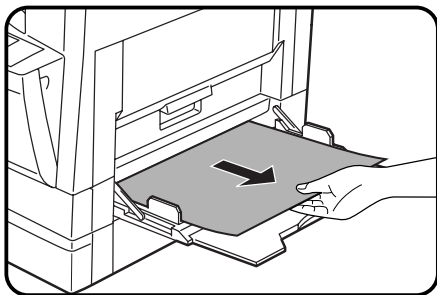
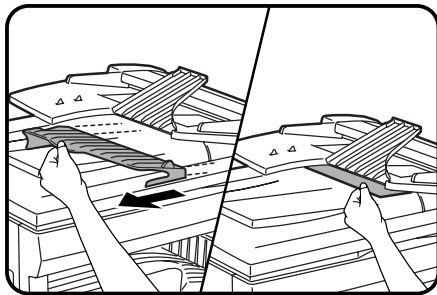
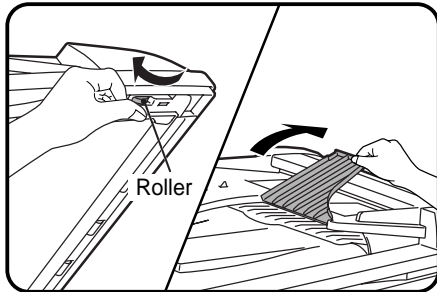

3 If the misfed original cannot be removed in steps 1 and 2, remove the misfed original from the exit area. Open the document feeder cover and rotate the roller in the direction indicated by the arrow if needed. If the misfed original cannot be easily removed from the exit area, open the front part of the document feeder tray to remove the original. Pull out the reversing tray to remove the misfed original.



Note

After removing the misfed original from the exit area, be sure to insert the reversing tray into the exit area until it locks in place.

4 Open and close the document feeder cover to cancel the misfeed location indicator.



Note

After misfed originals are removed, a number may appear in the copy quantity display, indicating the number of originals that must be returned to the document feeder tray. Return the originals and press the START key to resume copying.

Misfeed in the bypass tray

1 Gently pull the misfed paper out.

2 Lift slightly on the side cover and slide the cover out until it stops. Close the side cover by pressing the handle on the cover.

- The misfeed (⌘) indicator will go out.

Misfeed in the copier

1 Open the bypass tray. Lift slightly on the side cover and slide the cover out until it stops.

MISFEED REMOVAL

2 Check the misfeed location. Remove the misfed paper following the instructions for each location in the illustration below.

If the misfed paper is seen from this side, proceed to "C. Misfeed in the transport area".

If paper is misfed here, proceed to "A. Misfeed in the paper feed area".

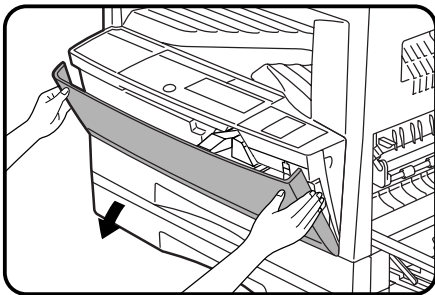
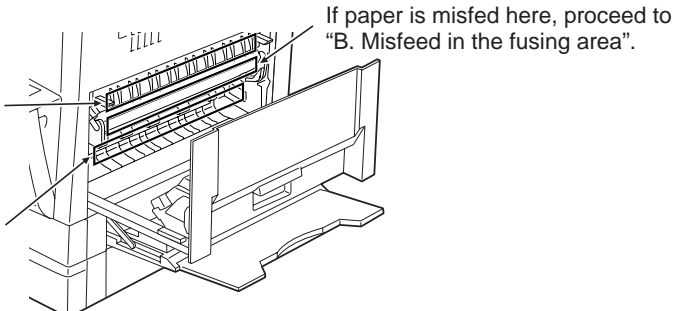

A. Misfeed in the paper feed area

1 Push gently on both sides of the front cover to open the cover.

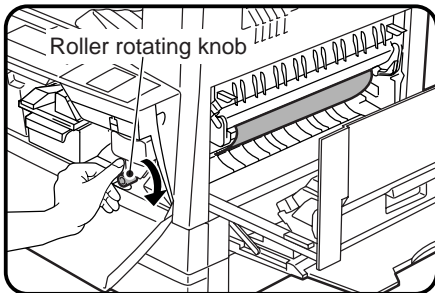

2 Carefully remove the misfed paper. Turn the roller rotating knob in the direction of the arrow to assist in removing it.

Warning The fusing unit is hot. Take care in removing paper.

Caution Do not touch the photoconductive drum (green portion) when removing the misfed paper. Doing so may damage the drum and cause smudges on copies.

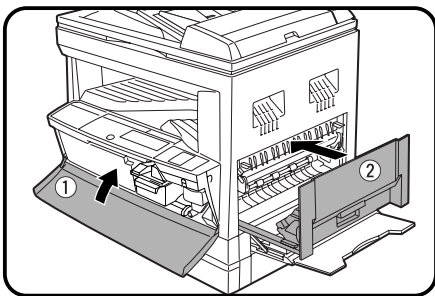

3 Close the front cover by pushing both sides with your hands and then close the side cover by pressing the handle on the cover.

- The misfeed (8V) indicator will go out.

Caution When closing the covers, be sure to close the front cover securely and then close the side cover. If the covers are closed in the wrong order, the covers may be damaged.

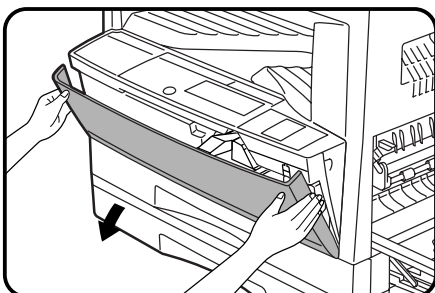

B. Misfeed in the fusing area

1 Push gently on both sides of the front cover to open the cover.

STATUS INDICATORS

8V Misfeed removal

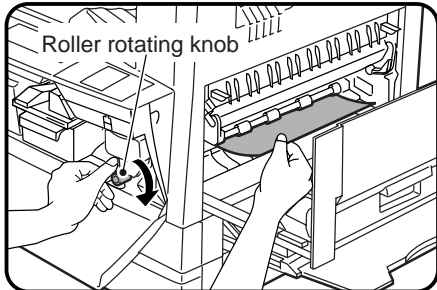

2 Turn the roller rotating knob in the direction of the arrow.

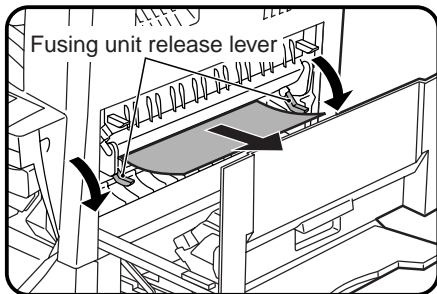

3 Carefully remove the misfed paper. Lower the fusing unit release levers to allow easier removal. Return the release levers to their operating positions.



The fusing unit is hot. Take care in removing paper.

Warning



Caution

- Do not touch the photoconductive drum (green portion) when removing the misfed paper. Doing so may damage the drum and cause smudges on copies.
- Be careful about unfixed toner on the misfed paper not to soil your hands or clothes.

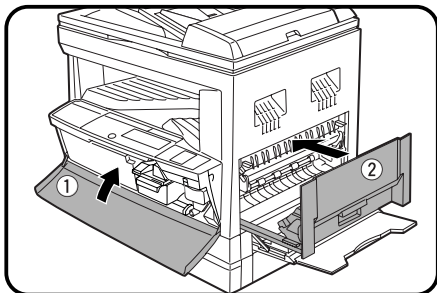

4 Close the front cover by pushing both sides with your hands and then close the side cover by pressing the handle on the cover.

- The misfeed (8A) indicator will go out.



Caution

When closing the covers, be sure to close the front cover securely and then close the side cover. If the covers are closed in the wrong order, the covers may be damaged.

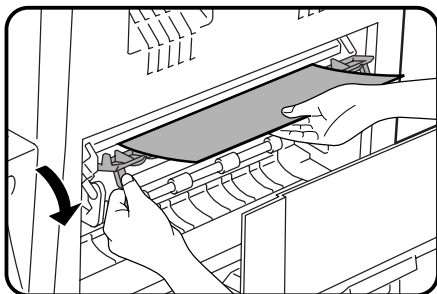

C. Misfed in the transport area

1 Open the paper guide by pressing down the projection on either side of the guide and remove the misfed paper.



The fusing unit is hot. Take care in removing paper.

Warning

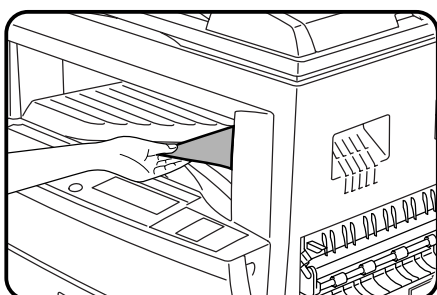

2 If the misfed paper cannot be removed by the previous step but is visible in the paper output area, remove the paper by pulling it into the paper output area.

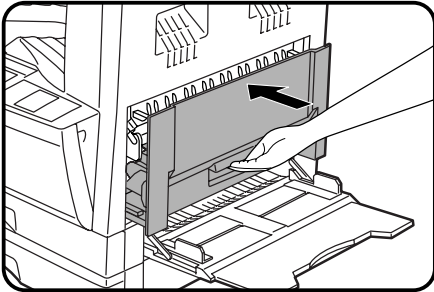

3 Close the side cover by pressing the handle on the cover.

- The misfeed (8A) indicator will go out.

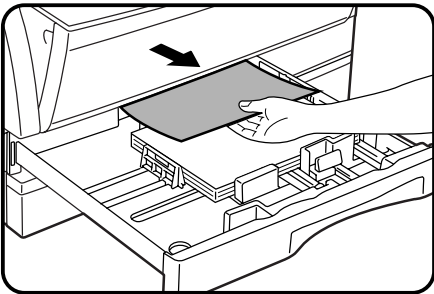

Misfeed in the upper paper tray

Before opening the upper paper tray, be sure to open the bypass tray, lift slightly on the side cover and slide the cover out until it stops, and then perform steps 1 to 3 described in the “A. Misfeed in the paper feed area” section.

1 Gently lift and pull out the upper paper tray and remove the misfed paper.

2 Close the paper tray.

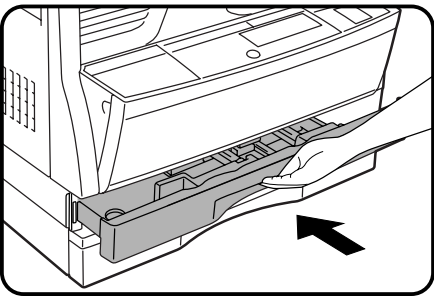

3 Lift slightly on the side cover and slide the cover out until it stops. Close the side cover by pressing the handle on the cover.

- The misfeed (8A) indicator will go out.

Misfeed in the lower paper tray

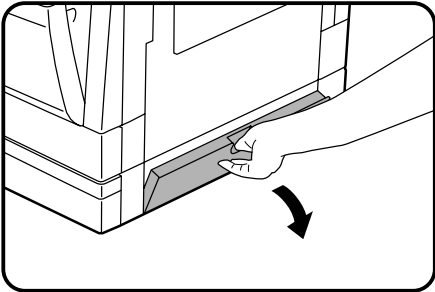

1 Grasp the handle of the lower side cover and gently open the cover.

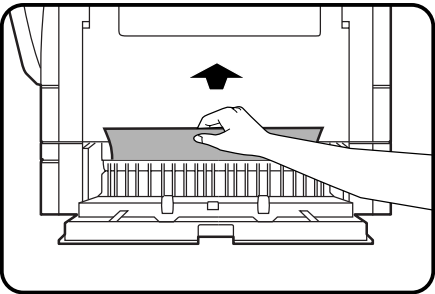

2 Remove the misfed paper.
 • Be careful not to tear the misfed paper during removal.

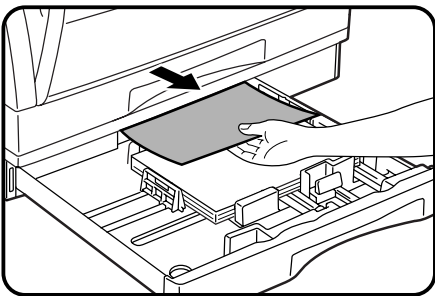

3 If the misfed paper is not seen in step 2, gently lift and pull out the lower paper tray and remove the misfed paper.
 • Be careful not to tear the misfed paper during removal.

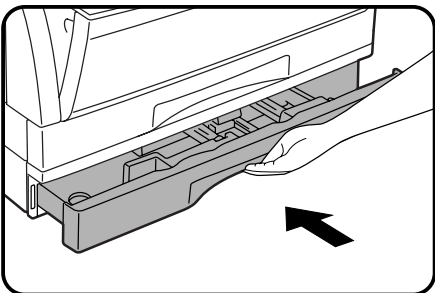

4 Close the paper tray.

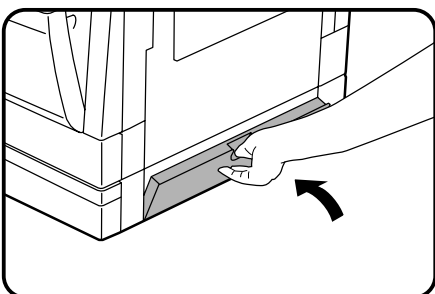

5 Close the lower side cover.
 • The misfeed (8V) indicator will go out.



DEVELOPER REQUIRED

When the  indicator lights up, the developer should be replaced. DEVELOPER REPLACEMENT SHOULD ONLY BE DONE BY AN AUTHORIZED SHARP SERVICE TECHNICIAN. Contact your service center as soon as possible.



MAINTENANCE REQUIRED

When the  indicator lights up, service by an authorized SHARP service technician is required. Contact your service center as soon as possible.

STATUS
INDICATORS

 Developer required/
 Maintenance required

USER PROGRAMS

The user programs allow the parameters of certain functions to be set, changed, or canceled as desired.

List of user programs

This copier has the following user programs.

Program No.	Program name	Description
1	Auto clear time	Sets the auto clear time. The copier returns to the initial settings when the auto clear time elapses after the last copy is made.
2	Preheat mode	Sets the time that elapses before the copier enters the preheat mode after any operation is made. See page 58.
3	Auto power shut-off timer	Sets the time that elapses before the copier enters the auto power shut-off mode after any operation is made. See page 58.
4	Stream feeding mode	Enables or disables the stream feeding mode. See page 14.
5	Auto power shut-off setting	Enables or disables the auto power shut-off mode. See page 58.
6	Border line for 2 in 1 or 4 in 1	Enables or disables the border line which is printed in 2 in 1 or 4 in 1 copying. See page 37.
7	Rotation copy	Enables or disables rotation of original images. See page 36.
8	Auto paper select mode	Enables or disables the auto paper selection. See page 15.
9	Auto tray switching	Enables or disables the automatic tray switching which occurs when paper in a tray runs out. (This switching cannot switch to the bypass tray.)
10	Auditing mode	Enables or disables the auditing mode, which controls access to copier. See page 13.
11	Account number entry	Registers accounts for auditing mode.
12	Account number change	Changes account numbers for auditing mode.
13	Account number deletion	Deletes accounts for auditing mode.
14	Number of copies per account	Displays the total number of copies made against account numbers.
15	Resetting account	Resets all audit accounts or resets any desired individual account.
16	Erase width adjustment	Sets the amount of the edge erase and center erase areas. See page 39.
17	Layout in 2 in 1 copy	Selects a pattern for 2 in 1 copying. See page 37.
18	Layout in 4 in 1 copy	Selects a pattern for 4 in 1 copying. See page 37.
19	Offset of paper output tray	Enables or disables the offset function of the paper output tray. The offset function can be specified respectively for the upper and lower areas separated by an optional job separator tray. See page 27.
20	Image rotation in duplex copying	Enables or disables image rotation (180°) of the front side in one-sided to two-sided copying or two-sided to one-sided copying. See page 22.
22	Location of the margin	Selects the location of the expanded margin. See page 41.

Setting the user programs

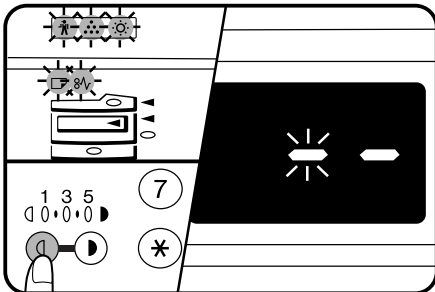

1 Press and hold the light (ⓐ) key for more than 5 seconds until all the alarm indicators (Ⓜ, Ⓝ, Ⓞ, Ⓟ, and Ⓠ) blink and “-” appears in the copy quantity display.

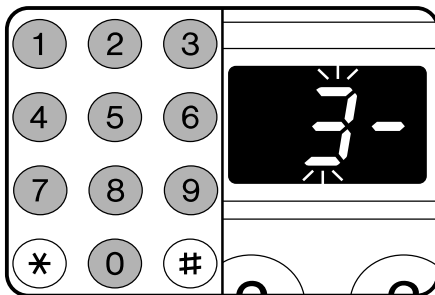

2 Enter a program number using the numeric keys.

- The selected program number will blink in the copy quantity display.
- If a mistake is made in steps 2 to 4, press the CLEAR (Ⓢ) key. The copier will return to step 2.
- The program numbers are shown in the table below.
For example, to change the setting of the auto power shut-off timer, press key 3.

Program name	Program No.
Auto clear time	1
Preheat mode	2
Auto power shut-off timer	3
Stream feeding mode	4
Auto power shut-off setting	5
Border line for 2 in 1 or 4 in 1	6
Rotation copy	7
Auto paper select mode	8
Auto tray switching	9
Auditing mode	10
Account number entry	11
Account number change	12
Account number deletion	13
Number of copies per account	14
Resetting account	15
Erase width adjustment	16
Layout in 2 in 1 copy	17
Layout in 4 in 1 copy	18
Offset of paper output tray	19
Image rotation in duplex copying	20
Location of the margin	22

For operation of these programs after step 3, see page 54.

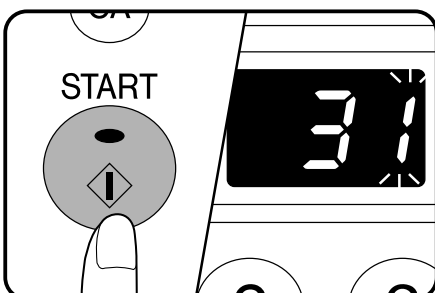

3 Press the START key.

- For programs 1 to 9 and 16 to 22, the entered program number will be steadily lit on the left side of the copy quantity display and the currently selected parameter number for the program will blink on the right side.
- For programs 10 to 15 (programs for auditing accounts), the display varies with the program number. See page 54 for setting programs 10 to 15.

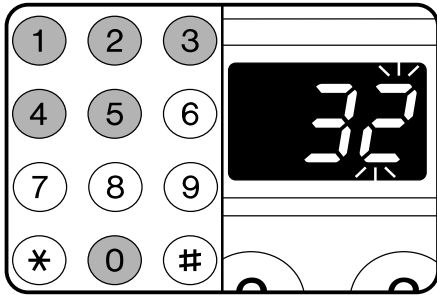

- 4 Select the desired parameter using the numeric keys.**
- The entered parameter number will blink on the right side of the copy quantity display.
 - The parameters are shown in the table below.
- For example, to change the setting of the auto power shut-off timer to 60 min., press key 2.

Program name	Parameters
Auto clear time	0 ⇨ OFF 1 ⇨ 30 sec. * 2 ⇨ 60 sec. 3 ⇨ 90 sec. 4 ⇨ 120 sec. 5 ⇨ 10 sec.
Preheat mode	0 ⇨ OFF 1 ⇨ 30 sec. 2 ⇨ 60 sec. * 3 ⇨ 90 sec. 4 ⇨ 120 sec.
Auto power shut-off timer	* 1 ⇨ 30 min. 2 ⇨ 60 min. 3 ⇨ 90 min. 4 ⇨ 120 min. 5 ⇨ 240 min.
Stream feeding mode	* 0 ⇨ OFF 1 ⇨ ON
Auto power shut-off setting	0 ⇨ OFF * 1 ⇨ ON
Border line for 2 in 1 or 4 in 1	* 0 ⇨ OFF 1 ⇨ ON
Rotation copy	0 ⇨ OFF * 1 ⇨ ON
Auto paper select mode	0 ⇨ OFF * 1 ⇨ ON
Auto tray switching	0 ⇨ OFF * 1 ⇨ ON
Erase width adjustment	0 ⇨ 0" 1 ⇨ 1/4" * 2 ⇨ 1/2" 3 ⇨ 3/4" 4 ⇨ 1"
Layout in 2 in 1 copy	* 1 ⇨ Pattern 1 2 ⇨ Pattern 2
Layout in 4 in 1 copy	* 1 ⇨ Pattern 1 2 ⇨ Pattern 2 3 ⇨ Pattern 3 4 ⇨ Pattern 4
Offset of paper output tray	0 ⇨ Upper OFF, lower OFF * 1 ⇨ Upper ON, lower ON 2 ⇨ Upper ON, lower OFF 3 ⇨ Upper OFF, lower ON
Image rotation in duplex copying	* 0 ⇨ OFF 1 ⇨ ON
Location of the margin	* 1 ⇨ Left 2 ⇨ Top

Factory default settings are indicated with an asterisk (*). For layout in 2 in 1 copy and 4 in 1 copy, see page 37.

 If you select "0" (OFF) in a program, the corresponding function will be disabled.

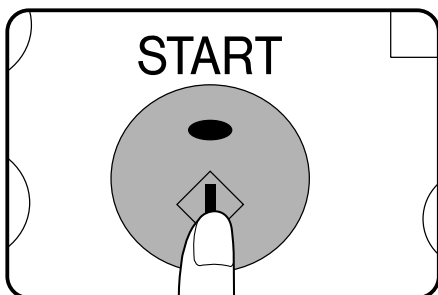

- 5 Press the START key.**
- The right-hand number in the copy quantity display will be steadily lit and the entered value will be stored.

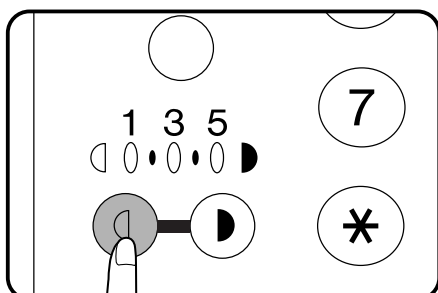

- 6 To continue with other user programs, press the (C) key and then repeat steps 2 to 5. To exit the user program mode, press the light (D) key.**
- All the alarm indicators will go out.

Settings for auditing accounts

Setting of user programs No. 10 to 15 varies with the program number. For settings of all programs, first follow steps 1 to 3 in “Setting the user programs” on page 52 to select a program. (1. Press the light (Ⓞ) key for more than 5 seconds. 2. Enter a program number (10 to 15) using the numeric keys. 3. Press the START key.) Then follow the appropriate instructions for the program.

Program No. 10: Auditing mode

If the auditing mode is enabled, copying is limited to operators with an assigned 3-digit account number. A maximum of 20, 3-digit account numbers can be assigned. Use program No. 11 to register account numbers.

When program No. 10 is entered, the current setting (0: OFF, 1:ON) will blink on the right side of the copy quantity display.

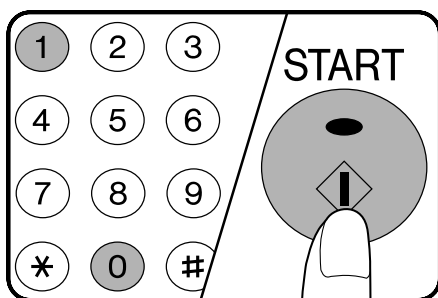

1. **Select the desired setting using the numeric keys.**
 - 0: OFF
 - 1: ON
2. **Press the START key.**
 - The setting will be stored.
3. **To continue with other user programs, press the (Ⓞ) key and enter another program number. To exit the user program mode, press the light (Ⓞ) key.**

Program No. 11: Account number entry

Program No. 11 is used to register accounts. When program No. 11 is entered, “ ” will blink in the copy quantity display.

- If the number of accounts has reached the upper limit (20), “11E” will appear in the copy quantity display. Press the (Ⓞ) key. The copier will return to step 2 on page 52.

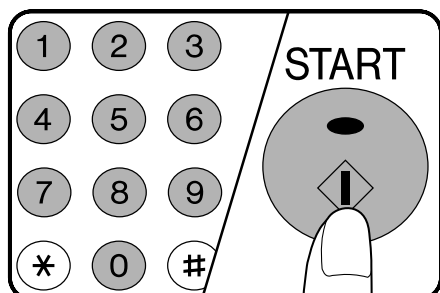

1. **Enter a 3-digit account number using the numeric keys.**
 - Any 3-digit number except “000” can be registered as an account number.
2. **Press the START key.**
 - If a number that is already registered or “000” is entered, the number will blink in the copy quantity display.
3. **Repeat steps 1 and 2 for other account numbers.**
4. **To continue with other user programs, press the (Ⓞ) key and enter another program number. To exit the user program mode, press the light (Ⓞ) key.**

Program No. 12: Account number change

Program No. 12 is used to change account numbers. When program No. 12 is entered, an account number will appear in the copy quantity display.

- If no account number has been registered, “12E” will appear in the copy quantity display. Press the (C) key. The copier will return to step 2 on page 52.

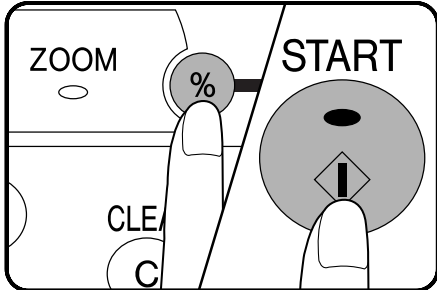

1. Use the copy ratio display (%) key to select the account number to be changed.

- Use the (%) key to advance through the account numbers.

2. Press the START key.

- The account number will be erased and “ ” will blink in the copy quantity display.

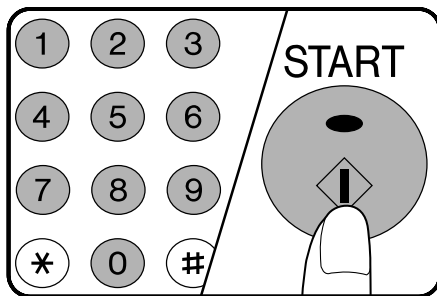

3. Enter a new account number using the numeric keys.

4. Press the START key.

- If a number that is already registered or “000” is entered, the number will blink in the copy quantity display.

5. Repeat steps 1 to 4 for other account numbers.

6. To continue with other user programs, press the (C) key and enter another program number. To exit the user program mode, press the light (Q) key.

Program No. 13: Account number deletion

Program No. 13 is used to delete accounts. When program No. 13 is entered, “0” will blink on the right side of the copy quantity display.

- If no account number has been registered, “13E” will appear in the copy quantity display. Press the (C) key. The copier will return to step 2 on page 52.

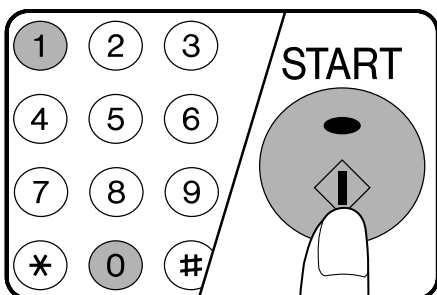

1. To delete an individual account, press the 0 key. To delete all accounts, press key 1.

2. Press the START key.

- If you have pressed the 0 key in step 1, an account number will appear in the copy quantity display. Proceed to step 3.
- If you have pressed key 1, all account numbers will be deleted. Proceed to step 5.

3. Use the copy ratio display (%) key to select the account number to be deleted.

- Use the (%) key to advance through the account numbers.

4. Press the START key.

- The specified account will be deleted.

5. To continue with other user programs, enter another program number. To exit the user program mode, press the light (Q) key.

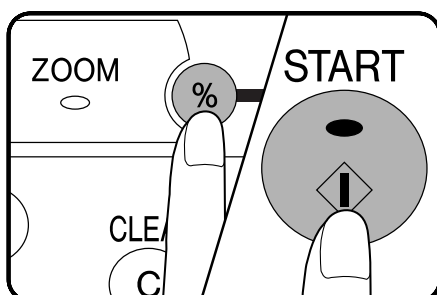

Program No. 14: Number of copies per account

Program No. 14 is used to display the total number of copies made against each account number. When program No. 14 is entered, an account number will appear in the copy quantity display.

- If no account number has been registered, "14E" will appear in the copy quantity display. Press the C key. The copier will return to step 2 on page 52.

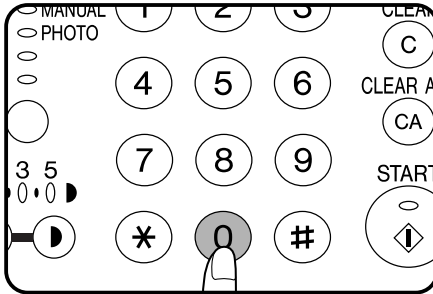
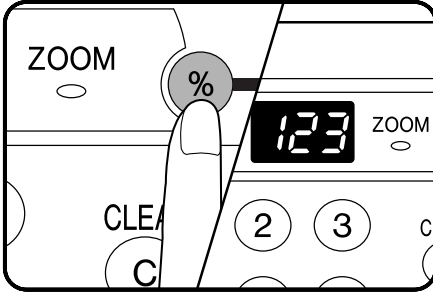

1. Use the copy ratio display (%) key to select the account number.

- Use the (%) key to advance through the account numbers.

2. Press and hold down the 0 key.

- The number of copies made against the specified account number will be displayed. The two higher digits and the three lower digits will appear alternately while the 0 key is pressed.

Example: 1,234 copies

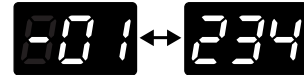

- The upper limit for the number of copies is 49,999. If the number of copies made reaches 50,000, the number will be reset to 0 and counting will start again from 0.

3. Repeat steps 1 and 2 for other account numbers.

4. To continue with other user programs, press the C key and select another program number. To exit the user program mode, press the light (D) key.

Program No. 15: Resetting account

Program No. 15 is used to reset all accounts or to reset any desired individual account. When program No. 15 is entered, "0" will blink on the right side of the copy quantity display.

- If no account number has been registered, "15E" will appear in the copy quantity display. Press the (C) key. The copier will return to step 2 on page 52.

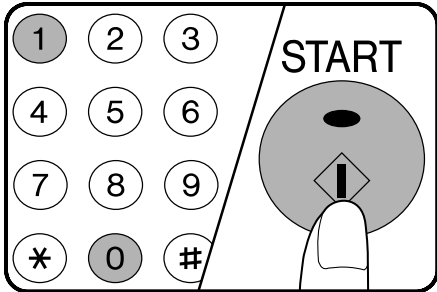

1. **To reset an individual account, press the 0 key. To reset all accounts, press key 1.**

2. **Press the START key.**

- If you have pressed the 0 key in step 1, an account number will appear in the copy quantity display. Proceed to step 3.
- If you have pressed key 1, the number of copies against all account numbers will be reset. Proceed to step 5.

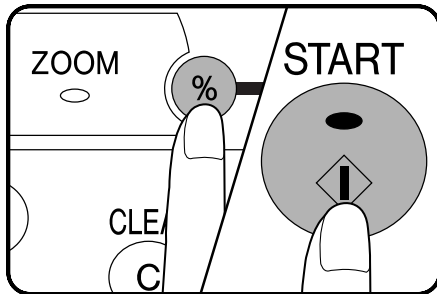

3. **Use the copy ratio display (%) key to select the account number to be reset.**

- Use the (%) key to advance through the account numbers.

4. **Press the START key.**

- The number of copies against the specified account number will be reset.

5. **To continue with other user programs, enter another program number. To exit the user program mode, press the light (L) key.**

POWER SAVE MODES

The copier has two power save modes to reduce overall power consumption thereby reducing the cost of operation. In addition, these modes conserve natural resources and help reduce environmental pollution. The two power save modes are preheat mode and auto power shut-off mode.

- User programs

The preheat activation time and the auto power shut-off time have been preset at the factory to 90 sec. for preheat mode and 30 min. for auto power shut-off mode. These times can be changed using user programs. It is suggested that you set appropriate times according to the actual usage of the copier. See page 51.

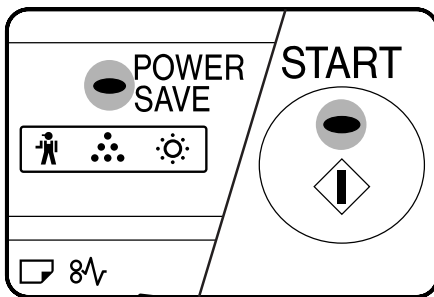

Preheat mode

When the copier enters the preheat mode, the POWER SAVE indicator will light up and other indicators will remain on or off as before. In this condition, the fuser in the copier is maintained at a lower heat level, thereby saving power. The preheat level is, however, high enough to allow the copier to come to a ready condition or begin copying within 10 seconds after any key input or copier operation such as paper tray operation is performed.

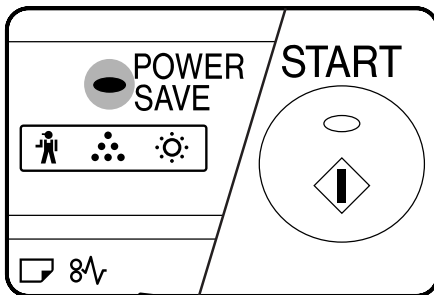

Auto power shut-off mode

If the auto power shut-off mode is enabled, the copier will automatically turn off the power once a programmed length of time has elapsed without any copier operation after the last copy of a run is made or the power is first turned on. The power switch will automatically be turned to the "OFF" position. To turn the power back on, simply turn the power switch to the "ON" position.

- If an optional printer expansion kit or facsimile expansion kit is installed and this mode is enabled, the POWER SAVE indicator will light up and all other indicators will go out. The auto power shut-off mode saves more power but requires a longer time to warm up before copying can begin.

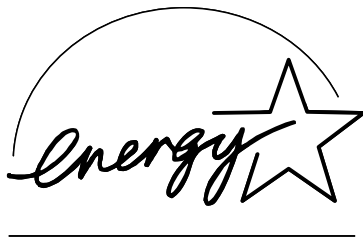

As an ENERGY STAR® Partner, SHARP has determined that this product meets the ENERGY STAR® guidelines for energy efficiency.



The Environmental Choice Program guidelines are applied to the products only in Canada. The products that meet the Environmental Choice Program guidelines carry the logo shown to the left. The products without the logo may not meet the Environmental Choice Program guidelines.

Setting the power save modes

The time that elapses before the copier enters a power save mode after any operation is made can be set manually. This time is set with user program No. 2 for the preheat mode and user program No. 3 for the auto power shut-off mode. For these settings, see page 52.

- The copier will enter the preheat mode first and then the auto power shut-off mode after a preset time has elapsed when no copier operation has been made.
- If conflicting settings are made with user programs No. 3 and No.5, the last program set will have priority.

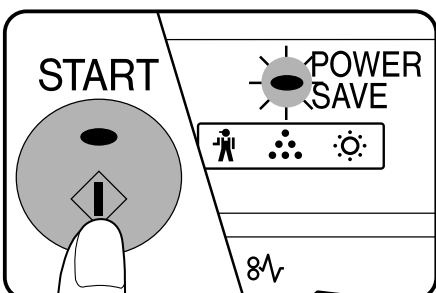
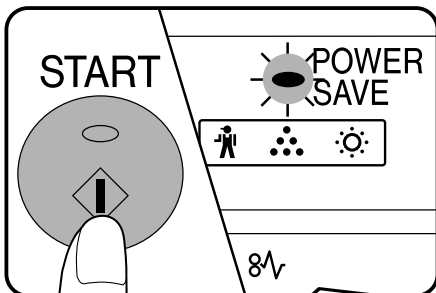
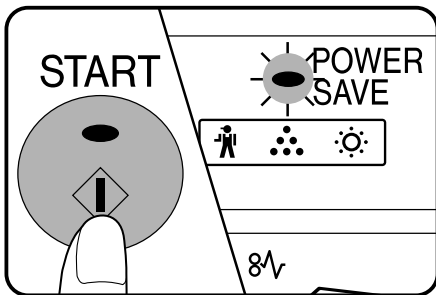

Copying from the preheat mode

Make desired copier selections and press the START key using the normal copying procedure.

- When any key input is made or any other copier operation is made, the POWER SAVE indicator will start to blink.
- When the START key is pressed, the START key indicator will go out and copying will start within 10 seconds. The POWER SAVE indicator will go out when copying starts.

Copying from the auto power shut-off mode

- Only available when an optional printer expansion kit or facsimile expansion kit is installed.

1 Press the START key.

- The copier will exit the auto power shut-off mode and the POWER SAVE indicator will start to blink.

2 Make desired copier selections and press the START key using the normal copying procedure.

- It will take approximately 35 seconds for the copier to start copying. However, you can make desired settings and press the START key during warm-up. Copying will start after warm-up is finished.

USER MAINTENANCE

Proper care is essential for clean, sharp copies. Please take a few minutes to regularly clean your copier.

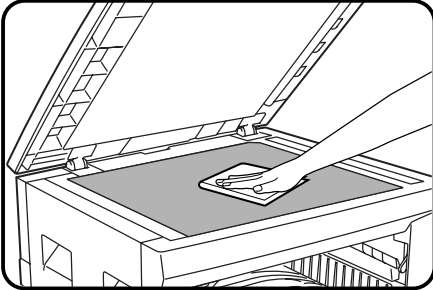

Original table and document feeder cover

Stains or dirt on the original table or document feeder cover will also be copied. Wipe the original table and document feeder cover with a soft, clean cloth.

- If necessary, dampen the cloth with water. Do not use thinner, benzene, or similar volatile cleaning agents.

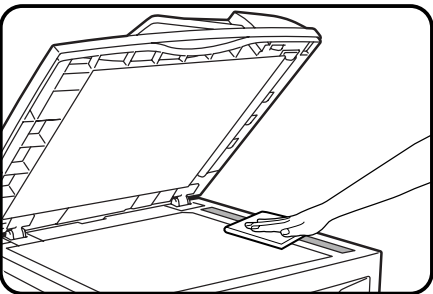
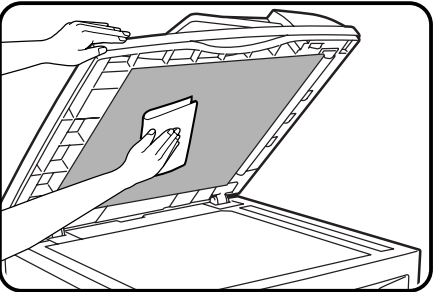

- Wipe the scanning window on the original table.

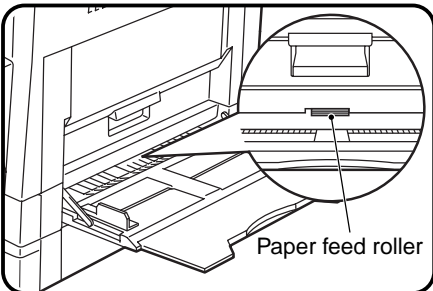

Bypass tray paper feed roller

If misfeeds occur frequently when feeding postcards, envelopes, thick paper, etc. through the bypass tray, wipe the blue paper feed roller at the feed slot of the bypass tray with a soft, clean cloth dampened with alcohol or water.

Transfer charger cleaning

If copies start becoming streaky or blotchy, the transfer charger may be dirty. Clean the charger using the following procedure.

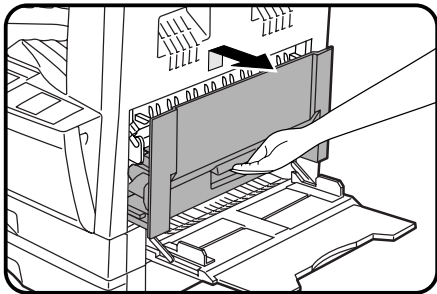

- 1** Turn the power switch off.
- 2** Open the bypass tray. Lift slightly on the side cover and slide the cover out until it stops.

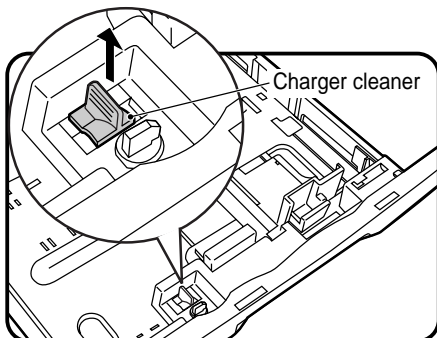

- 3** Gently lift and pull out the upper paper tray and take the charger cleaner out by holding the tab.

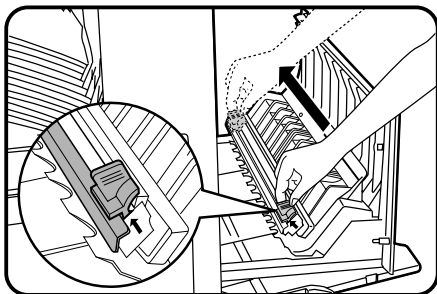

- 4** Set the charger cleaner onto the transfer charger and gently slide the cleaner in the direction indicated by the arrow two or three times.



Caution

Slide the charger cleaner from one end to the other end along the groove of the transfer charger. If the cleaner is stopped on the way, smudges on copies may occur.





- If the white sheet metal is smudged with toner, wipe it with a soft, clean cloth.

- 5** Return the charger cleaner to its original position. Close the upper paper tray. Close the side cover by pressing the handle on the cover.

- 6** Turn the power switch on.

COPIER TROUBLE?

Problem	Solution	
Copier does not operate.	<ul style="list-style-type: none"> ● Copier plugged in? 	Plug the copier into a grounded outlet. See page 8.
	<ul style="list-style-type: none"> ● Power switch ON? 	Turn the power switch ON. See page 14.
Copies are too dark or too light.	<ul style="list-style-type: none"> ● Copy density properly adjusted? 	See pages 15 and 30.
Blank copies	<ul style="list-style-type: none"> ● Is the original placed face up in the RSPF or face down on the original table? 	Place the original face up in the RSPF or face down on the original table.
Copies smear if rubbed.	<ul style="list-style-type: none"> ● Paper too heavy? 	Use copy paper within the specified range. See page 65.
	<ul style="list-style-type: none"> ● Paper damp? 	Replace with dry copy paper. Be sure to store copy paper in a dry location. See page 66.
Striped copies	<ul style="list-style-type: none"> ● Is transfer charger clean? 	Clean the transfer charger. See page 61.
Paper misfeeds frequently.	<ul style="list-style-type: none"> ● Non-standard paper used? 	Use standard paper. If using special paper, feed the paper through the bypass tray. See pages 25 and 65.
	<ul style="list-style-type: none"> ● Paper properly installed? 	Make sure the paper is properly installed. See pages 10 and 25.
	<ul style="list-style-type: none"> ● Pieces of paper inside copier? 	Remove all pieces of misfed paper. See page 44.
	<ul style="list-style-type: none"> ● Paper curled or damp? 	Store paper flat in the wrapper in a dry location. See page 66.
Original size not selected automatically.	<ul style="list-style-type: none"> ● Has the document feeder cover been completely opened when the original is placed on the original table? 	Open the document feeder cover completely and then place the original on the original table. Close the document feeder cover.
	<ul style="list-style-type: none"> ● Does the original include any large black solid areas? 	If the original includes any large black solid areas, the original size may not be detected. Use the ORIGINAL SIZE ENTER key to select the paper size which is set.

Problem	Solution	
Copies are smudged or dirty.	<ul style="list-style-type: none"> ● Original table or document feeder cover dirty? 	Clean regularly. See page 60.
	<ul style="list-style-type: none"> ● Original smudged or blotchy? 	Use a clean original.
	<ul style="list-style-type: none"> ● Is the  indicator on? 	Developer is required. Contact your SHARP service center as soon as possible. See page 50.
	<ul style="list-style-type: none"> ● Is the  indicator on? 	Maintenance is required. Contact your SHARP service center as soon as possible. See page 50.
Paper size for a paper tray cannot be set.	<ul style="list-style-type: none"> ● Is the COPY indicator off? 	Use the COPY/FAX key to select the COPY mode. See Note below.
	<ul style="list-style-type: none"> ● Is copying, printing or facsimile printing being performed? 	Set the paper size after copying, printing or facsimile printing is complete.
Power is on but copying is not possible.	<ul style="list-style-type: none"> ● Is the POWER SAVE indicator blinking? 	Wait until warm-up is complete. Warm-up time is approximately 35 seconds.
	<ul style="list-style-type: none"> ● Is only the POWER SAVE indicator on? (when an optional printer or facsimile expansion kit is installed) 	The copier is in the auto power shut-off mode. Press the START key. See page 58, POWER SAVE MODES.
	<ul style="list-style-type: none"> ● Is the COPY indicator off? 	Use the COPY/FAX key to select the COPY mode. See Note below.
	<ul style="list-style-type: none"> ● Is  steadily lit in the copy quantity display? 	The copier is in the auditing mode. Enter your account number using the numeric keys. See page 13.
	<ul style="list-style-type: none"> ● Is the  indicator on? 	Paper is needed. See page 10, LOADING COPY PAPER.



Note

COPY/FAX key

The COPY/FAX key is used to switch between the FAX and COPY modes. For details, see the MULTI ACCESS manual.

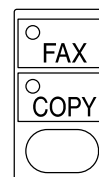

Problem	Solution	
Power is on but copying is not possible.	<ul style="list-style-type: none"> Is the output tray full (◀) indicator on and any misfeed location (◀) indicator blinking while the misfeed (8V) indicator is not blinking? 	Remove the paper on or under the job separator tray so that it can move to the proper position, and then open and close the side cover.
	<ul style="list-style-type: none"> Is two-sided printing being performed? 	Wait until the printing job will finish.
	<ul style="list-style-type: none"> Is CH blinking in the copy quantity display? 	The toner cartridge is not installed. Install the toner cartridge. If "CH" is blinking even if the cartridge is installed properly, contact your SHARP service center immediately.
	<ul style="list-style-type: none"> Is CH steadily lit in the copy quantity display? 	Side cover(s) is open. Close the front and side covers securely.
	<ul style="list-style-type: none"> Is the  indicator blinking? 	The toner cartridge must be replaced. See page 42, TONER CARTRIDGE REPLACEMENT.
	<ul style="list-style-type: none"> Is the 8V indicator blinking? 	A misfeed has occurred. See page 44, MISFEED REMOVAL.
Lighting fixture flickers.	<ul style="list-style-type: none"> Is the same power outlet used for the lighting fixture and the copier? 	Connect the copier to a power outlet which is not used for other electric appliances.



Caution

Be sure to use only genuine SHARP parts and supplies.

Please contact your SHARP service center immediately if a problem persists after checking the above.

Self-diagnostic function

An automatic self-diagnostic function is built into the copier. Should the copier malfunction, the self-diagnostic function will locate the problem and stop the copier to prevent damage. An alphanumeric code will appear in the copy quantity display.

Example

Should the copier completely stop and a letter and a number appear alternately, contact your SHARP service center immediately.

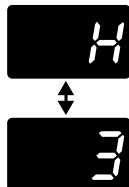

SUPPLIES

Types and sizes of copy paper

	Size	Weight	Capacity (21 lb. bond paper)	Special paper
Paper trays	5-1/2" x 8-1/2"* to 11" x 17"	15 lbs. to 21 lbs.	250 sheets	
Bypass tray	Ordinary paper: 5-1/2" x 8-1/2" to 11" x 17" Envelopes: Commercial 10 (4-1/8" x 9-1/2") International DL (110 x 220 mm) International C5 (162 x 229 mm)	15 lbs. to 34 lbs.** (Ordinary paper)	100 sheets	Transparency film, labels, envelopes***

* 5-1/2" x 8-1/2" copy paper can be used in the uppermost paper tray but cannot be used in other trays (including trays in optional paper feed units).

** For paper weighing from 28 to 34 lbs., 8-1/2" x 11" is the maximum size that can be fed through the bypass tray.

*** Do not use envelopes that have metal clasps, plastic snappers, string closures, windows, linings, self-adhesive patches or synthetic materials. These will cause physical damage to the copier.

- For best results, use only paper recommended by SHARP.
- Special papers except envelopes must be fed one sheet at a time through the bypass tray. Up to 10 envelopes can be set at one time.

Genuine supplies statement

Standard supplies for this copier that are to be replaced by the user are copy paper and toner cartridge.

For best copying results, be sure to use only SHARP Genuine Supplies which are designed, engineered and tested to maximize the life and performance of SHARP copiers. Look for the Genuine Supplies label on the toner package.



Proper storage

- 1. Store the supplies in a location that is:**
 - clean and dry,
 - at a stable temperature,
 - not exposed to direct sunlight.
- 2. Store paper in the wrapper and lying flat.**
 - Paper stored out of the wrapper or in packages standing on end may curl or get damp, resulting in paper misfeeds.

SPECIFICATIONS

Type	Digital laser copier, desktop
Copy system	Dry, electrostatic transfer
Originals	Sheets, bound documents
Original sizes	Max. 11" x 17"
Copy sizes	Max. 11" x 17" Min. 5-1/2" x 8-1/2" Image loss: Max. 5/32" (4 mm) (leading and trailing edges) Max. 5/32" (4 mm) (along other edges in total)
Copying speed (one-sided copying at 100% copy ratio)	20 copies/min. (8-1/2" x 11") 15 copies/min. (8-1/2" x 11"R) 12 copies/min. (8-1/2" x 14") 10 copies/min. (11" x 17")
Continuous copy	Max. 99 copies; subtractive counter
First-copy time	7.2 s (except in a power save mode)
Warm-up time	Approx. 35 s
Copy ratio	Variable: 50% to 200%, in 1% increments (total 151 steps) Fixed preset: 50%, 64%, 77%, 95 %, 100%, 121%, 129%, 141%, 200%
Exposure system	Original table: Moving optical source, slit exposure (stationary platen) with automatic exposure function RSPF: Moving original
Copy paper feed	Two paper trays with automatic feed (250 sheets each), one bypass tray with automatic feed (100 sheets)
Fusing system	Heat rollers
Developer system	Magnetic brush development
Light source	Xenon lamp
Resolution	Scan: 400 dpi Output: 600 dpi
Gradation	Scan: 256 levels Output: 2 levels
Power supply	AC 120V, 60 Hz, 11 amperes
Power consumption	Max. 1.3 kW
Overall dimensions (with bypass tray folded)	23-15/64" (W) x 20-29/32" (D) (590 mm (W) x 531 mm (D))

SPECIFICATIONS

Weight	Approx. 94.9 lbs. (43 kg) Toner cartridge included
Copier dimensions	23-15/64" (W) x 20-29/32" (D) x 25-19/32" (H) (590 mm (W) x 531 mm (D) x 650 mm (H))
Operating conditions	Temperature: 59°F to 86°F (15°C to 30°C) Humidity: 20% to 85%
Optional equipment	250-sheet paper feed unit (AR-DE5) 2x250-sheet paper feed unit (AR-DE6) Facsimile expansion kit (AR-FX2) Printer expansion kit (AR-PB8) PS2 expansion kit (AR-PS1) LCD panel kit (AR-PA1) Job separator tray kit (AR-TR2) Print server card (AR-NC3D)

REVERSING SINGLE PASS FEEDER

Acceptable originals	Weight: 15 to 24 lbs. Size: 5-1/2" x 8-1/2"* to 11" x 17" Capacity: Up to 30 sheets provided the total aggregate thickness does not exceed 5/32" * 5-1/2" x 8-1/2" size original cannot be used in the duplex mode.
Detectable original sizes	5-1/2" x 8-1/2", 8-1/2" x 11", 8-1/2" x 11"R, 8-1/2" x 14", 11" x 17"

First-copy time may differ depending on operating conditions, such as power-supply voltage and room temperature.



Note

As a part of our policy of continuous improvement, SHARP reserves the right to make design and specification changes for product improvement without prior notice. The performance specification figures indicated are nominal values of production units. There may be some deviations from these values in individual units.

OPTIONAL EQUIPMENT

CONTENTS

	Page
• SYSTEM CONFIGURATION	70
• 250-SHEET PAPER FEED UNIT (AR-DE5)/ 2x250-SHEET PAPER FEED UNIT (AR-DE6)	71

SYSTEM CONFIGURATION

A number of options are available for the copier which allow you to configure a copier system to meet your particular needs. The options include the following.

Facsimile expansion kit (AR-FX2)*
Printer expansion kit (AR-PB8)*
PS2 expansion kit (AR-PS1)*
LCD panel kit (AR-PA1)*
Job separator tray kit (AR-TR2)*
Print server card (AR-NC3D)*

* These options are not used for the copier operation.

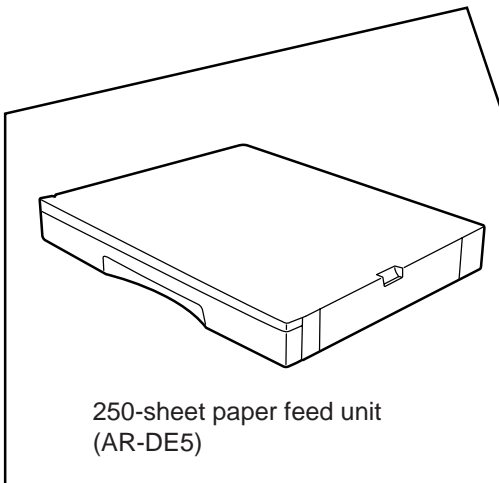
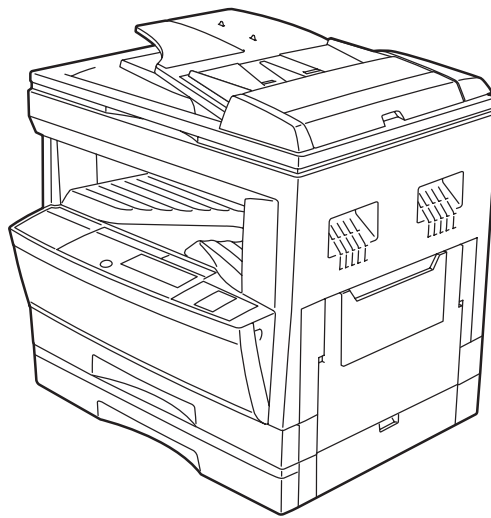

250-sheet paper feed unit
(AR-DE5)

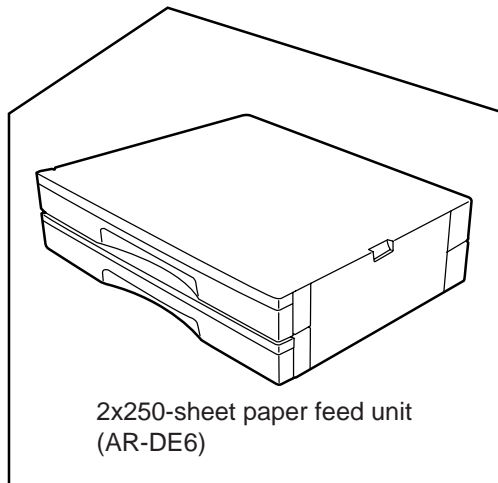

2x250-sheet paper feed unit
(AR-DE6)

250-SHEET PAPER FEED UNIT (AR-DE5) 2x250-SHEET PAPER FEED UNIT (AR-DE6)

These paper feed units as options provide the convenience of increased paper capacity for the copier and a greater choice of paper sizes readily available for copying.

The AR-DE5 contains one 250-sheet paper tray and the AR-DE6 contains two 250-sheet paper trays.

PART NAMES

250-sheet paper feed unit

AR-DE5

2 x 250-sheet paper feed unit

AR-DE6

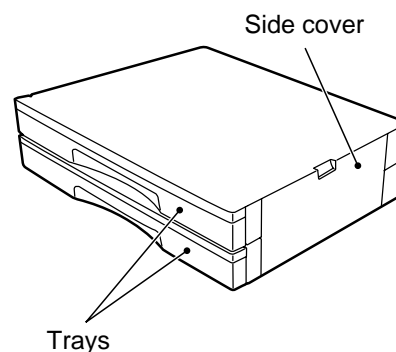
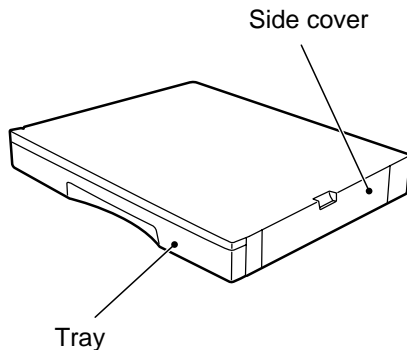

Loading copy paper

The method of loading paper for the paper trays of these paper feed units is the same as for the paper trays in the copier. See page 10.

The method of changing the copy paper size is also the same for the paper trays in the copier. See page 11.

250-sheet paper feed unit (AR-DE5)
2x250-sheet paper feed unit (AR-DE6)

OPTIONAL
EQUIPMENT

Misfeed removal

The copier will stop when a misfeed occurs. The misfeed (⚠) indicator and the red indicator which indicates the paper feed unit will blink.

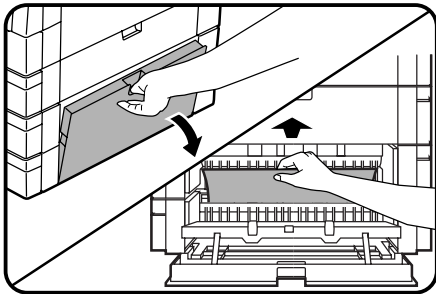

1 Open the side cover of the paper feed unit and remove the misfed paper.

- Be sure to perform this step before pulling out the paper trays. If not, the paper may be torn as the trays are opened.

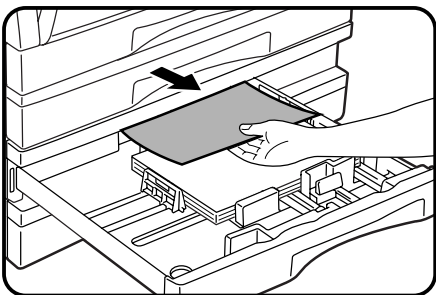

2 Gently lift and pull out the paper tray which was in use. Remove any misfed paper.

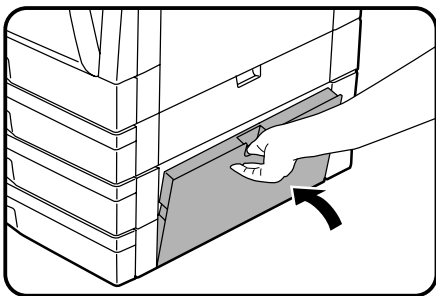

3 Close the paper tray and the side cover.

- Confirm that the misfeed (⚠) indicator has gone out.

250-sheet paper feed unit (AR-DE5)
2x250-sheet paper feed unit (AR-DE6)

OPTIONAL
EQUIPMENT

Specifications

AR-DE5

Copy paper size	8-1/2" x 11" to 11" x 17"
Paper weight	15 lbs. to 21 lbs.
Paper capacity	One paper tray with capacity for 250 sheets of 21 lb. bond paper
Weight	Approx. 10.4 lbs. (4.7 kg)
Dimensions	23-15/64" (W) x 18-35/64" (D) x 3-15/32" (H) (590 mm (W) x 471 mm (D) x 88 mm (H))
Power supply	Drawn from the copier

AR-DE6

Copy paper size	8-1/2" x 11" to 11" x 17"
Paper weight	15 lbs. to 21 lbs.
Paper capacity	Two paper trays with capacity for 250 sheets of 21 lb. bond paper each
Weight	Approx. 20.1 lbs. (9.1 kg)
Dimensions	23-15/64" (W) x 18-35/64" (D) x 6-27/32" (H) (590 mm (W) x 471 mm (D) x 173.5 mm (H))
Power supply	Drawn from the copier



Note

As a part of our policy of continuous improvement, SHARP reserves the right to make design and specification changes for product improvement without prior notice. The performance specification figures indicated are nominal values of production units. There may be some deviations from these values in individual units.

250-sheet paper feed unit (AR-DE5)
2x250-sheet paper feed unit (AR-DE6)

OPTIONAL
EQUIPMENT

INDEX

- 2**
250-sheet paper feed unit 71
2 in 1 37
2x250-sheet paper feed unit 71
- 4**
4 in 1 37
- A**
Auto clear 7, 51
Automatic exposure adjustment 30
Auto paper select 7, 51
Auto power shut-off mode 58
- B**
B/W reverse 34
Bypass tray 25
- C**
Cautions on handling 9
Copier trouble? 62
Copying
– normal 14
– from the original table 19
– reduction/enlargement 23
– through bypass tray 25
Copy paper 10, 65
Copy quantity 16
Copy ratio 23
- D**
Dark key 15
Developer replacement required indicator 50
Document feeder cover 4
Document feeder tray 5
Dual page copy 35
- E**
Enlargement 23
Erase 39
Exposure adjustment 15
- F**
Features 3
Fixed copy ratio 24
Fusing unit release lever 47
- G**
Group 27
- I**
Image rotation in duplex copying 22
Initial settings 7
Interrupt 29
- L**
Light key 15, 43, 52
Loading copy paper 10
- M**
Maintenance
– user maintenance 60
– maintenance required indicator 50
Manual exposure 15
Manual feeding 25
Margin shift 41
Misfeed removal
– bypass tray 45
– in the copier 45
– paper tray 48, 49, 72
– RSPF 44
- N**
Names
– operation panel 6
– part 4
- O**
Offset 27, 51
Operation panel 6
Options 69
Original table 4
- P**
Paper
– loading 10
– special 25
– specifications 65
Paper output tray 4
Paper size 65
Paper tray 10
Part names 4
Photo mode 15
Power on 14
Power save modes 58
Power switch 14
Preheat mode 58

R	
Reduction	23
Replacement	
– toner cartridge	42
Reversing single pass feeder (RSPF)	14
Rotation copying	36
RSPF	14
S	
Sort	27
Special paper	25
Specifications	
– copier	67
– paper	65
Status indicators	42
Storage of supply	66
Stream feeding mode	14
T	
Toner cartridge life	43
Toner cartridge replacement	42
Toner save mode	31
Total output count	6
Troubleshooting	62
Two-sided copying	16, 21
U	
User maintenance	
– bypass tray paper feed roller	60
– document feeder cover	60
– original table	60
– transfer charger	61
User programs	51
X	
XY zoom	32
Z	
Zoom	24

MATERIAL SAFETY DATA SHEET

MSDS No. F-00991

Section 1. Product Identification

Product:

AR-201NT/T/FT/ST (Black Toner)

Section 2. Supplier's Name and Address

Sharp Corporation

22-22 Nagaike-cho, Abeno-ku, Osaka, Japan

Local suppliers are listed below. Please contact the nearest supplier for additional information.

(Country)	(Name and Telephone Number)
U.S.A.	Sharp Electronics Corporation Telephone number for information: 1-800-237-4277 Emergency telephone number: 1-800-255-3924
Canada	Sharp Electronics of Canada Ltd. Telephone number for information: 905-890-2100 Emergency telephone number: 1-800-255-3924
United Kingdom	Sharp Electronics (U.K.) Ltd. Telephone number for information: 01923-474013

Section 3. Ingredients

Ingredients	CAS No.	Proportion	OSHA PEL	ACGIH TLV	Other Limits
Styrene-Acrylate copolymer	29497-14-1	> 88 %	Not listed	Not listed	None
Carbon black	1333-86-4	< 6.0%	3.5mg/m ³	3.5mg/m ³	None
Iron oxide	1309-38-2	< 4.5%	Not listed	Not listed	None
Metal Complex dye	{ 109125-51-1 { 109125-50-0 { 84179-66-8	< 1.5%	0.5mg/m ³	0.5mg/m ³	None

Section 4. Hazardous Identification (Emergency Overview)

Toner is a fine, black powder possessing no immediate hazard. There are no anticipated carcinogenic effects from exposure based on animal tests performed using toner. When used as intended according to instructions, studies do not indicate any symptoms of fibrosis will occur.

Section 5. Health Hazard Data

Route(s) of Entry:	<u>Inhalation?</u> Yes	<u>Skin?</u> No	<u>Ingestion?</u> Possible but very unusual.
---------------------------	---------------------------	--------------------	---

Health Hazards: Acute oral toxicity ----- LDLo of this toner is over 2,000mg/kg.
Mutagenicity ----- The result of Ames test is negative.

Carcinogenicity: In 1996 the IARC reevaluated carbon black as a Group 2B carcinogen (possible human carcinogen). This classification is given to chemicals for which there is inadequate human evidence, but sufficient animal evidence on which to base an opinion of carcinogenicity. The classification is based upon the development of lung tumors in rats receiving chronic inhalation exposures to free carbon black at levels that induce particle overload of the lung. Studies performed in animal models other than rats did not show any association between carbon black and lung tumors. Moreover, a two-year cancer bioassay using a typical toner preparation containing carbon black demonstrated no association between toner exposure and tumor development in rats.

Chronic Effect: In a study in rats of chronic inhalation exposure to a typical toner, a mild to moderate degree of lung fibrosis was observed in 92% of the rats in the high concentration (16mg/m³) exposure group, and a minimal to mild degree of fibrosis was noted in 22% of the animals in the middle (4mg/m³) exposure group, but no pulmonary change was reported in the lowest (1mg/m³) exposure group, the most relevant level to potential human exposures.

Signs and Symptoms of Exposure: Minimal irritation to respiratory tract may occur as with exposure to any non-toxic dust.

Medical Conditions Generally Aggravated by Exposure: None

Emergency and First Aid Procedures:

Inhalation; Remove to fresh air. If effects occur, consult medical personnel.
Eye; In case of contact, immediately flush eyes with water for 15 minutes.

Section 6. Physical Chemical Characteristics

Boiling / Melting Point:	Not applicable	Specific Gravity:	1.1
Vapor Pressure:	Not applicable	Solubility in Water:	Negligible
Vapor Density:	Not applicable	PH:	Not applicable
Evaporation Rate:	Not applicable	Viscosity:	Not applicable
Appearance:	Fine powder	Color:	Black
Odor:	Odorless		

Section 7. Fire and Explosion Data

Flash Point (Method Used):	Not applicable		
Ignition Temperature:	>350°C		
Flammable Limits:	(LEL); Not applicable	(UEL); Not applicable	
Extinguishing Media:	CO ₂ , dry chemical, foam or water		
Special Fire Fighting Procedure:	None		
Unusual Fire and Explosion Hazard:	This material has no unusual fire or explosion hazards.		
Sensitivity to Mechanical Impact:	None		
Sensitivity to Static Charge:	None		

Section 8. Reactivity Data

Stability:	Stable
Incompatibility (Material to Avoid):	None
Hazardous Decomposition:	CO and NO _x
Hazardous Polymerization:	Will not occur.

Section 9. Precautions for Safe Handling and Use

Personal Protection Information (Respiratory, Eye Protection and Protective Glove):

Use of a dust mask is recommended when handling a large quantity of toner or during long term exposure, as with any non-toxic dust.

Engineering Control / Ventilation:	Not required.
Work / Hygienic Practice:	Inhalation should be minimized as with any non-toxic dust.
Steps to be taken in case of Spill or Leak:	Sweep up or clean up with vacuum cleaner.
Waste Disposal Method:	Waste material may be dumped or incinerated under conditions which meet all federal, state and local environmental regulations.

Section 10. Regulatory Information

NFPA Rating (U.S.A.):	Health = 1	Flammability = 1	Reactivity = 0
WHMIS Legislation (Canada):	This product is not a controlled product.		
Transport Information:	This product is not a hazardous material.		
UN No.:	None allocated.		

Section 11. Other Information

References: IARC (1996) IARC Monographs on the Evaluation of the Carcinogenic Risk of Chemicals to Humans, Vol. 65, Printing Process and Printing inks, Carbon Black and Some Nitro Compounds, Lyon, pp. 149-261
H. Muhle, B. Bellmann, O. Creutzenberg, C. Dasenbrock, H. Ernst, R. Kilpper, J. C. MacKenzie, P. Morrow, U. Mohr, S. Takenaka, and R. Mermelstein (1991) Pulmonary Response to Toner upon Chronic Inhalation Exposure in Rats. Fundamental and Applied Toxicology 17, pp. 280-299

MATERIAL SAFETY DATA SHEET

MSDS No. F-30991

Section 1. Product Identification

Product

AR-201ND/DV/SD (Black Developer)

Section 2. Supplier's Name and Address

Sharp Corporation

22-22 Nagaike-cho, Abeno-ku, Osaka, Japan

Local suppliers are listed below. Please contact the nearest supplier for additional information.

(Country)	(Name and Telephone Number)
U.S.A.	Sharp Electronics Corporation Telephone number for information: 1-800-237-4277 Emergency telephone number: 1-800-255-3924
Canada	Sharp Electronics of Canada Ltd. Telephone number for information: 905-890-2100 Emergency telephone number: 1-800-255-3924
United Kingdom	Sharp Electronics (U.K.) Ltd. Telephone number for information: 01923-474013

Section 3. Ingredients

<u>Ingredients</u>	<u>CAS No.</u>	<u>Proportion</u>	<u>OSHA PEL</u>	<u>ACGIH TLV</u>	<u>Other Limits</u>
Iron powder	7439-89-6	> 92.5%	Not listed	Not listed	None
Styrene-Acrylate copolymer	29497-14-1	< 7.0%	Not listed	Not listed	None
Carbon black	1333-86-4	< 0.5%	3.5mg/m ³	3.5mg/m ³	None

Section 4. Hazardous Identification (Emergency Overview)

Developer is a black powder containing small amounts of toner, and possessing no immediate hazard.

There are no anticipated carcinogenic effects from exposure based on animal tests performed using toner.

Section 5. Health Hazard Data

Route(s) of Entry:	<u>Inhalation?</u> No	<u>Skin?</u> No	<u>Ingestion?</u> Possible but very unusual.
---------------------------	--------------------------	--------------------	---

Health Hazards: Acute oral toxicity -----LDLo of this toner which is included in this developer is over 2,000mg/kg.

Mutagenicity -----The toner, which is included in this developer, has been tested on Ames test. The result is negative.

Carcinogenicity: In 1996 the IARC reevaluated carbon black as a Group 2B carcinogen (possible human carcinogen). This classification is given to chemicals for which there is inadequate human evidence, but sufficient animal evidence on which to base an opinion of carcinogenicity. The classification is based upon the development of lung tumors in rats receiving chronic inhalation exposures to free carbon black at levels that induce particle overload of the lung. Studies performed in animal models other than rats did not show any association between carbon black and lung tumors.

While there have been no studies to date using developer, a two-year cancer bioassay using a typical toner preparation containing carbon black (a small amount of toner is included in the developer mixture) demonstrated no association between toner exposure and tumor development in rats.

Signs and Symptoms of Exposure: Minimal irritation to respiratory tract may occur as with exposure to any non-toxic dust.

Medical Conditions Generally Aggravated by Exposure: None

Emergency and First Aid Procedures:

Inhalation; Remove to fresh air. If effects occur, consult medical personnel.

Eye; In case of contact, immediately flush eyes with water for 15 minutes.

Section 6. Physical Chemical Characteristics

Boiling / Melting Point:	Not applicable	Specific Gravity:	about 7.3
Vapor Pressure:	Not applicable	Solubility in Water:	Negligible
Vapor Density:	Not applicable	PH:	Not applicable
Evaporation Rate:	Not applicable	Viscosity:	Not applicable
Appearance:	Fine powder	Color:	Black
Odor:	Odorless		

Section 7. Fire and Explosion Data

Flash Point (Method Used):	Not applicable		
Ignition Temperature:	>350°C		
Flammable Limits:	(LEL); Not applicable	(UEL); Not applicable	
Extinguishing Media:	CO ₂ , dry chemical, foam or water		
Special Fire Fighting Procedure:	None		
Unusual Fire and Explosion Hazard:	This material has no unusual fire or explosion hazards.		
Sensitivity to Mechanical Impact:	None		
Sensitivity to Static Charge:	None		

Section 8. Reactivity Data

Stability:	Stable
Incompatibility (Material to Avoid):	None
Hazardous Decomposition:	CO and NO _x
Hazardous Polymerization:	Will not occur.

Section 9. Precautions for Safe Handling and Use

Personal Protection Information (Respiratory, Eye Protection and Protective Glove):	
	None required under normal use.
Engineering Control / Ventilation:	Not required.
Work / Hygienic Practice:	Not required.
Steps to be taken in case of Spill or Leak:	Sweep up or clean up with vacuum cleaner.
Waste Disposal Method:	Waste material may be dumped or incinerated under conditions which meet all federal, state and local environmental regulations.

Section 10. Regulatory Information

NFPA Rating (U.S.A.):	Health = 1	Flammability = 1	Reactivity = 0
WHMIS Legislation (Canada):	This product is not a controlled product.		
Transport Information:	This product is not a hazardous material.		
UN No.:	None allocated.		

Section 11. Other Information

References:	IARC (1996) IARC Monographs on the Evaluation of the Carcinogenic Risk of Chemicals to Humans, Vol. 65, Printing Process and Printing inks, Carbon Black and Some Nitro Compounds, Lyon, pp-149-261 H. Muhle, B. Bellmann, O. Creutzenberg, C. Dasenbrock, H. Ernst, R. Kilpper, J. C. MacKenzie, P. Morrow, U. Mohr, S. Takenaka, and R. Mermelstein (1991) Pulmonary Response to Toner upon Chronic Inhalation Exposure in Rats. Fundamental and Applied Toxicology 17, pp. 280-299
--------------------	--

For users in the USA

WARNING:

FCC Regulations state that any unauthorized changes or modifications to this equipment not expressly approved by the manufacturer could void the user's authority to operate this equipment.

Note:

This equipment has been tested and found to comply with the limits for a Class A digital device, pursuant to Part 15 of the FCC Rules. These limits are designed to provide reasonable protection against harmful interference when the equipment is operated in a commercial environment. This equipment generates, uses, and can radiate radio frequency energy and, if not installed and used in accordance with the operation manual, may cause harmful interference to radio communications. Operation of this equipment in a residential area is likely to cause harmful interference in which case the user will be required to correct the interference at his own expense.

NOTICE for users in the USA

BE SURE TO ASK YOUR AUTHORIZED SHARP DEALER ABOUT THE WARRANTY THAT YOUR SELLING DEALER EXTENDS TO YOU. In order to assure you, the end-user, of warranty protection, Sharp extends a limited warranty to each of its authorized dealers and, in turn, requires each of its authorized dealers to extend its own warranty to you on terms that are no less favorable than those given to the dealer by Sharp. You should be aware, however, that Sharp does not itself extend any warranties, either express or implied, directly to you, the end-user, and no one is authorized to make any representations or warranties on behalf of Sharp. Specifically, SHARP DOES NOT EXTEND TO YOU, THE END-USER, ANY EXPRESS WARRANTY OR ANY IMPLIED WARRANTY OF MERCHANTABILITY, FITNESS FOR USE OR FITNESS FOR ANY PARTICULAR PURPOSE IN CONNECTION WITH THE HARDWARE, SOFTWARE OR FIRMWARE EMBODIED IN, OR USED IN CONJUNCTION WITH THIS PRODUCT. Sharp is not responsible for any damages or loss, either direct, incidental or consequential, which you, the end-user, may experience as a result of your purchase or use of the hardware, software or firmware embodied in or used in conjunction with this Product. Your sole remedy, in the event that you encounter any difficulties with this Product, is against the authorized dealer from which you purchased the Product.

AR-207 Digital Laser Copier

In the event that this authorized dealer does not honor its warranty commitments, please contact the General Manager, Business Products Group, Sharp Electronics Corporation, Sharp Plaza, Mahwah, NJ 07430-2135, so that Sharp can try to help assure complete satisfaction of all the warranty rights to which you are entitled from the authorized dealer.

SHARP[®]

SHARP ELECTRONICS CORPORATION

Sharp Plaza, Mahwah, New Jersey 07430-2135.

www.sharp-usa.com

SHARP ELECTRONICS OF CANADA LTD.

335 Britannia Road East, Mississauga, Ontario, L4Z 1W9

SHARP CORPORATION